

Stick SLT4 trim 18

adjustable LED single lamp pendant, with perforated diffuser

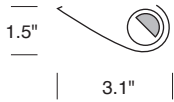
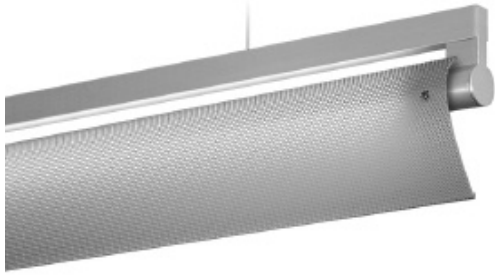

TRIM 18
Fully Perforated
White Reflector
with Acrylic Backing

CONSTRUCTION

- Single lamp 2, 3, 4, 6 or 8 ft. inline pendant fixture that may be installed stand-alone or connected to additional Stick sections. Each section requires its own power feed.
- Matte anodized extruded aluminum driver housing. 7/8" opening for direct conduit feed (not intended for J-box mount).
- 8 ft. gray adjustable power cord and aircraft cables, with push button grippers supplied, standard.
- Specify XP for additional length (25 ft. max.).
- cUL listed for damp locations.

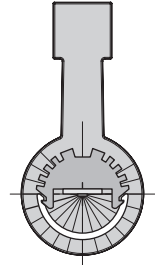

Lamp rotates 270°, in 15° stepped increments, to direct light where needed.

TYPE:	PROJECT:
ORDER NUMBER:	

MODEL#	LENGTH (FT.)	HO/LO	LEDS	DIMMING	EMERGENCY	OPTION	TRIM
SLT4—Stand-Alone	8	LO	W30	D—Standard	EM—Emergency	SFBS	18
SLTR4—Right	6	HO	W35	BDIM-W11		SFBW	
SLTM4—Middle	4		W40			SLRD	
SLTL4—Left	3					SLRDTB	
	2						

Example:

SLT4	8	HO	W35	D		SLRD	18
------	---	----	-----	---	--	------	----

XP—Extra power cord (in inches, 25 ft. max.):		S100P—J-box cover	
XL—custom lumen reduction (specify lumens):			

MODEL
SLT4.8.LO/HO
SLT4.6.LO/HO

LENGTH
8 ft.
6 ft.

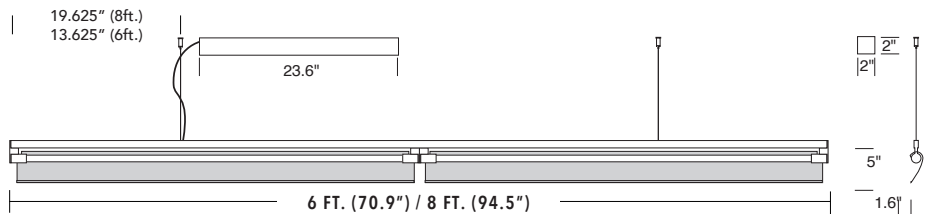

MODEL
SLT4.4.LO/HO
SLT4.3.LO/HO
SLT4.2.LO/HO

LENGTH
4 ft.
3 ft.
2 ft.

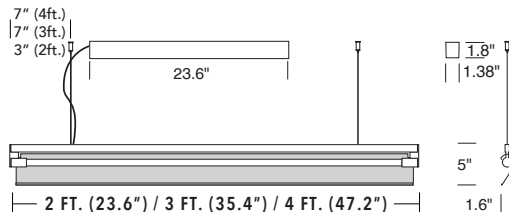

Stick SLT4 trim 18

adjustable LED single lamp pendant, with perforated diffuser



WHITE LEDS

Samsung tight bin chips on aluminum clad boards. 90 CRI. Specify color: W30–3000° Kelvin, W35–3500° Kelvin, or W40–4000° Kelvin color temperature.

DIMMING

- **D**—standard supplied driver. 0–10V, programmable, 1% dimming, 120/277V, 50/60 Hz.
- **BDIM-W11**—Lutron EcoSystem LED14 Series, 1% dimming, fade-to-off.

CUSTOM LUMEN OUTPUT REDUCTION

Factory set custom reduced-lumen output driver configuration. Order **XL**. Specify lumens.

WATTS / LUMENS / EFFICACY

LENGTH	WATTS	DELIVERED LUMENS	EFFICACY
2 ft. LO	8	722	103 LPW
2 ft. HO	16	1,443	103 LPW
3 ft. LO	12	1,082	103 LPW
3 ft. HO	23	2,165	103 LPW
4 ft. LO	16	1,443	103 LPW
4 ft. HO	31	2,886	103 LPW
6 ft. LO	23	2,165	103 LPW
6 ft. HO	47	4,330	103 LPW
8 ft. LO	31	2,886	103 LPW
8 ft. HO	62	5,772	103 LPW

CONNECTING SECTIONS

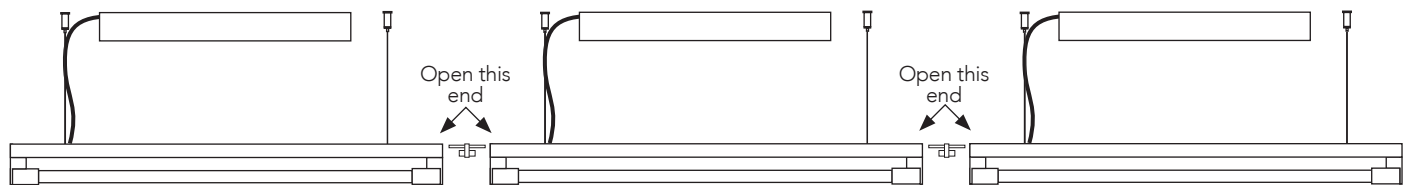

RIGHT

SLTR open on right side of cord

SLTR4.8.LO/HO
SLTR4.6.LO/HO
SLTR4.4.LO/HO
SLTR4.3.LO/HO
SLTR4.2.LO/HO

LENGTH

8 ft.
6 ft.
4 ft.
3 ft.
2 ft.

MIDDLE

SLTM open on both ends

SLTM4.8.LO/HO
SLTM4.6.LO/HO
SLTM4.4.LO/HO
SLTM4.3.LO/HO
SLTM4.2.LO/HO

LEFT

SLTL open on left side of cord

LENGTH

8 ft.
6 ft.
4 ft.
3 ft.
2 ft.

SLTL4.8.LO/HO
SLTL4.6.LO/HO
SLTL4.4.LO/HO
SLTL4.3.LO/HO
SLTL4.2.LO/HO

LENGTH

8 ft.
6 ft.
4 ft.
3 ft.
2 ft.

CONNECTORS

Stick's sliding support cable, on the end opposite the power cord, accommodates ceiling obstructions.

STJA

Swivel connector rotates 240° and adds 7/16" to overall length.

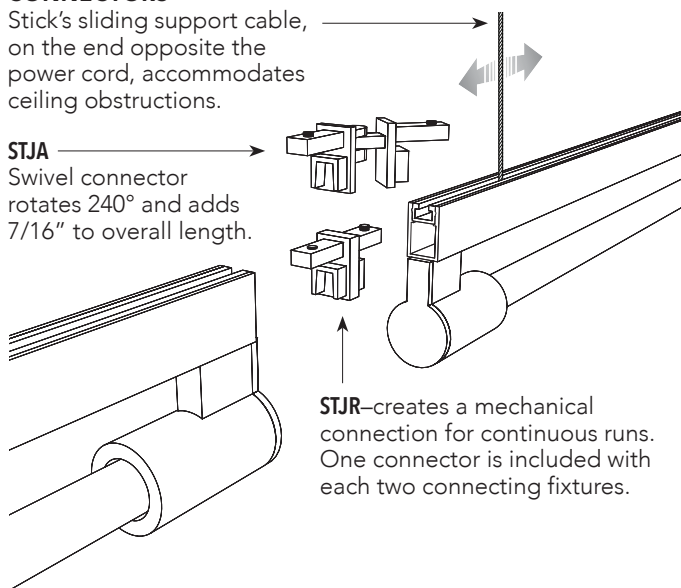

STJR—creates a mechanical connection for continuous runs. One connector is included with each two connecting fixtures.

EMERGENCY

For 4' through 8' fixtures only. Battery pack provides 10W for 90 minutes. Adds additional length to driver housing.

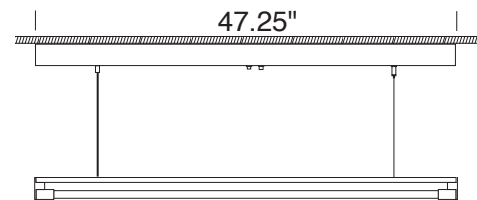

AIRCRAFT CABLE

NOTE: Not recommended for outdoor use, where fixture will be exposed to water, or subject to wind oscillation. Avoid use near HVAC vents and in environments with corrosive chemical vapors, such as swimming pools.

Stick SLT4 trim 18

adjustable LED single lamp pendant, with perforated diffuser



REMOTE DRIVERS

Drivers must be accessible after installation. Multiple driver housings must be mounted no closer than 4" apart side-by-side, or 1" apart end-to-end, to avoid overheating. Driver to canopy distance should not exceed 100 ft., using 10 AWG wire.

SLRD: Standard remote housing has no bar hangers and mounts to structure with screws. Dimensions: 24" length, 2.36" height, 2.65" width.

SLRDTB: Remote housing for T-bar ceiling includes bar hangers. Dimensions: 27" length, 3.4" height, 4.25" width.

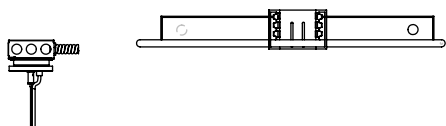

EM/SLRDTB: Remote **EM** housing for T-bar ceiling includes bar hangers and remote test switch. Dimensions: 36" length, 3.4" height, 4.25" width.

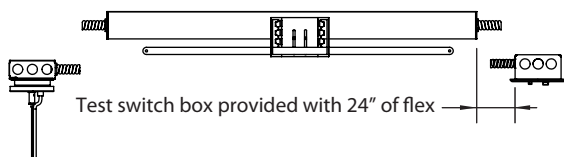

FLUSH MOUNT

22" flush mount ballast housing, for joist mount rough-in. Order **SFBS** (silver) or **SFBW** (white).

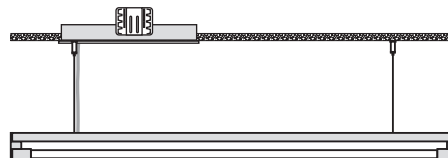

OPTIONAL J-BOX COVER

Cover plate mounts to maximum 4" square J-box. Ballast housing mounts to wall on top of cover plate, which may be painted to match ceiling or wall, and includes two mounting spacers to offset cover thickness. Order **S100P**.

