

Cylindro III (680)

circular LED pendant with opal acrylic diffuser

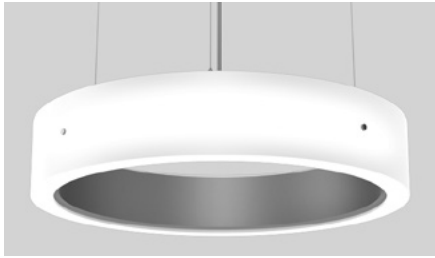

- 6 ft. power cord and adjustable aircraft cables, gripper supplied, standard. Default finish/power cord pairings are silver/gray, white/white, black/black.
- For RAL colors, power cord color must be specified.
- For differing fixture/canopy colors, please consult factory.
- Drivers and DMX module installed in surface mount canopy. For remote driver installation, see page 2.
- Drivers are universal voltage, 120–277V.

- Specify: **S, C**—standard canopy (10" x 2.25"), which mounts to all standard J-boxes; or **SR, CR, NCR**—remote canopy (3" x 0.45"), which mounts to 3" mud ring.
- cUL listed for dry and damp locations only.

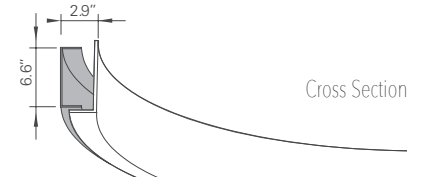

CONSTRUCTION

- Silver finish aluminum inner housing, with opal acrylic diffuser.

TYPE:	PROJECT:
ORDER NUMBER:	

MODEL#	FINISH	LEDS	MOUNT STYLE	DIMMING	OPTION
6813-3 ft., LO	S-Silver	W30	S-Separate	D -Standard	EM -Emergency
6814-4 ft., LO	W-White	W35	SR-Separate Remote	BDIM-W11	RR -Remote
6815-5 ft., LO	K-Black	W40	C-Central	DMX	Driver
6823-3 ft., HO	CC-RAL Color*	RGBW -color + ¹	CR-Central Remote	DA -DALI	
6824-4 ft., HO		3500° K white	NCR-Nexus CR		
6825-5 ft., HO	BW-Barn Wood				
6803-3 ft., RGBW	CB-Carbon Fiber				
6804-4 ft., RGBW	ES-Espresso				
6805-5 ft., RGBW	HK-Honey Oak				
	M-Maple				
	SD-Silver Driftwood				
	GF-Gold Leaf				
	CO-Copper				
	GT-Gold Textured				
	SA-Stainless Steel				

Example:

6815	BW	W35	SR	D	
------	----	-----	----	---	--

		XL- custom lumen reduction (specify lumens):	
		XP-Extra power cord (in inches, 25 ft. max.):	
		EB- Earthquake Bracing Kit (enter quantity):	
		Specify canopy finish (silver, white, black):	
		Specify power cord color (gray, white, black):	
		*Specify RAL color number:	

MOUNT STYLES

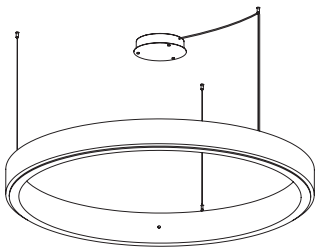

S - Separate

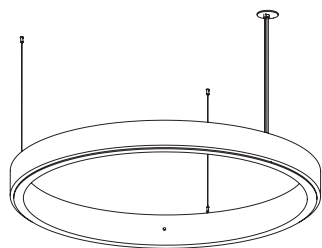

SR - Separate Remote

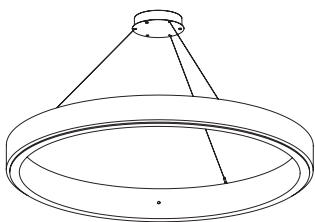

C - Central

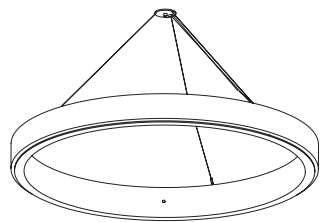

CR - Central Remote

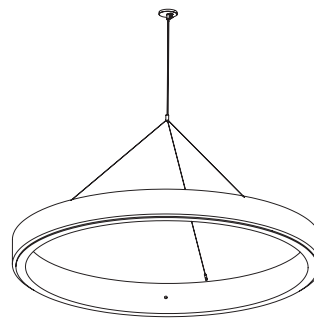

NCR - Nexus Central Remote

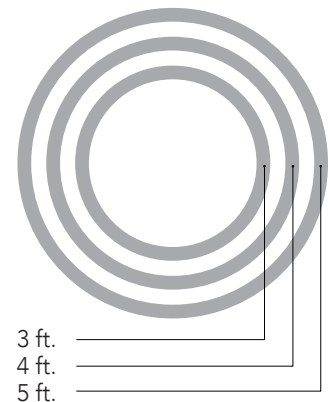

¹ Only available with DMX-512 (DMX) or DALI-2 (DA) dimming options.

Cylindro III (680)

circular LED pendant with opal acrylic diffuser



WHITE LEDS

Nichia Corp. NFSL757 tight bin chips, available in 6W per foot (**LO**–Low Output), or 11.2W per foot (**HO**–High Output). 90 CRI. Specify: **W30**–3000°, **W35**–3500°, or **W40**–4000° Kelvin.

CUSTOM LUMEN OUTPUT REDUCTION

Factory-set custom reduced-lumen output driver configuration. Order **XL**. Specify lumens.

COLOR LEDS

RGBW with 3500° K white. Only available with DMX-512 (DMX) or DALI-2 (DA) dimming options.

DIMMING

- **D**–standard supplied driver. 0–10V, programmable, 1% dimming, 120–277V, 50/60 Hz.
- **BDIM-W11**–Lutron EcoSystem LED14 Series, 1% dimming, 120–277V, fade-to-off. Remote (**SR, CR, NCR**) install only.
- **DA**–for both white and RGBW LEDs, DALI 1% dimming, fade-to-off. 120/277V, 50/60 Hz.
- **DMX**–for both white and RGBW LEDs, 1% dimming fade-to-off. 120–277V 50/60Hz.

WATTS / DELIVERED LUMENS / DRIVERS / CANOPY

WHITE LEDs				RGBW LEDs					
MODEL NO.	DIAMETER	WATTS	DELIVERED LUMENS	MODEL NO.	DIAMETER	WATTS	DELIVERED LUMENS	DRIVERS	CANOPY
6813	3 ft.-LO	51	2,747	6803	3 ft.	30	N/A	1	*
6814	4 ft.-LO	71	3,827	6804	4 ft.	40	N/A	1	*
6815	5 ft.-LO	90	4,846	6805	5 ft.	50	N/A	1	*
6823	3 ft.-HO	73	6,104					2	**
6824	4 ft.-HO	96	8,138					2	**
6825	5 ft.-HO	100	10,173					2	**

CANOPY DIMENSIONS

*Single Driver for **6803, 6804, 6805, 6813, 6814**: 11" OD x 2.296" ht. **Dual Driver for **6815, 6823, 6824, 6825**: 14.5" OD x 2.205" ht.

REMOTE DRIVERS

For suspended and hard lid ceilings with access panels. Canopy mounts to mud ring attached to J-box. Must be accessible after installation. Order **RR**.

Standard pendant length: 8 ft. Specify **XP** for extra pendant. Maximum canopy to fixture distance: 25 ft. Maximum canopy to driver distance: 100 ft. (with 10 AWG wire).



Remote Driver Canopy
3.8 x 0.45 in.

Max. Wiring Distance (at full load)

Wire Size (AWG)	Distance (ft.)
18	18
16	29
14	46
12	71
10	120

SR – Separate mount driver installation.

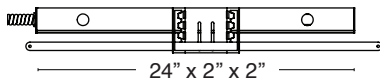

NOTE: Multiple drivers must be mounted no less than four inches apart side-by-side, and one inch apart end-to-end, to prevent overheating.

CR – Central mount remote driver installation.

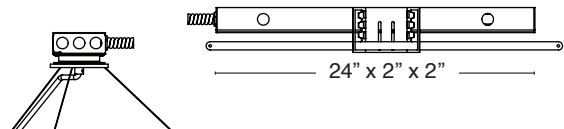

EM – Emergency. T-bar install shown, below. Emergency battery pack provides 10W for 90 minutes. Remote install only. Red driver light and test switch mounted in handy box installed at ceiling.

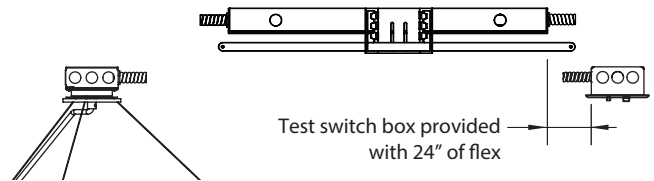

AIRCRAFT CABLE

NOTE: Not recommended for outdoor use, where fixture will be exposed to water, or subject to wind oscillation. Avoid use near HVAC vents and in environments with corrosive chemical vapors, such as swimming pools.

ACRYLIC DIFFUSER CLEANING

WARNING: Do not clean with ammonia based cleaners (e.g. Windex®). Use only water or cleaners specifically formulated for cleaning plastics.

Cylindro III (680)

circular LED pendant with opal acrylic diffuser



PAINT FINISHES



S-Silver



W-white



K-Black

TEXTURED FINISHES

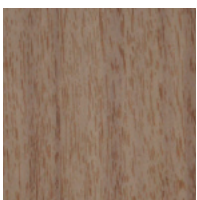

BW-Barnwood

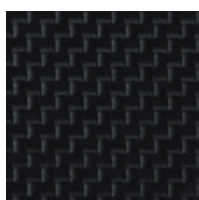

CB-Carbon Fiber



ES-Espresso



HK-Honey Oak

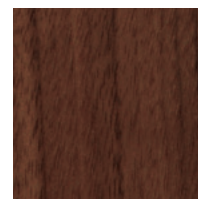

M-Maple



SD-Silver Driftwood

PREMIUM TEXTURED FINISHES

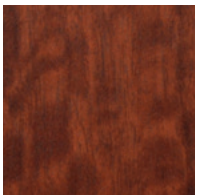

DC-Dark Cherry

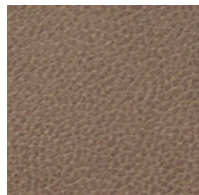

KL-Khaki Leather

METALLIC FINISHES

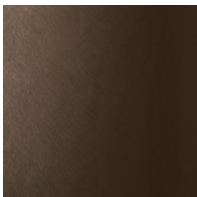

BR-Bronze



GF-Gold Leaf



CO-Copper



GT-Gold Textured



SA-Stainless Steel

TEXTURED FINISHES - CANOPY AND POWER CORD COLORS

Specify Silver, White, Black or RAL color for canopy.
Also specify Gray, White or Black power cord.