

RADAR

surface LED downlight with optional accent uplight



CONSTRUCTION

- Anodized satin aluminum driver canopy and reflector.
- Integral drivers accessible through fixture, including when mounted to conduit.
- **RGBW** is remote install only. Optional DMX wall box controller also available. Order **BDMXCON** separately. (See p. 2.)
- Optional accent uplight: Lens is clear acrylic, with frosted edge.
- Downlight LED engine is white or color-tuning **CT**. Uplight is white or **RGBW**. Downlight and accent light are separate-switched.
- Drivers are universal voltage (120–277V).
- Reflector interior is anodized, specular, durable and anti-iridescent. 30° cutoff (.30). Finish is Clear Alzak® Haze.
- cUL listed for dry and damp locations only (pending).

TYPE:	PROJECT:
ORDER NUMBER:	

MODEL#	LUMENS DOWN (White LEDs only)	LEDs DOWN	LEDs UP	FINISHES	DIMMING	MOUNT OPTION	OPTION
IL7600	LO - 2,000 MO - 3,000 HO - 4,000	W30 W35 W40 CT - Color Tuning	W30 W35 W40 RGBW - color + 3500° K white	SA - Satin Aluminum	D - Standard BDIM-W11 DA - DALI DMX DPH - Phase	CM1 - pipe mount RCO RC1 RC2 RC3	EM RR TB
Example:							
IL7600	HO	W35	B	SA	D	CM1	EM, TB

XL - custom lumen reduction (specify lumens, downlight only):	Specify CM1 pipe length (inches):
BDMXCON-W - white faceplate (enter quantity):	BDMXCON-B - black faceplate (enter quantity):

1/2" CONDUIT CONFIGURATIONS (specify one of three, below)

RC1 – one conduit feed for dead end or single fixture.

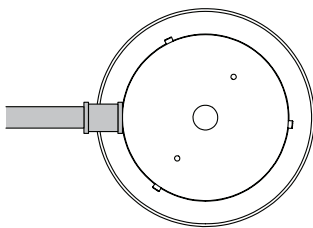

RC2 – two feeds 180° opposite, for straight runs.

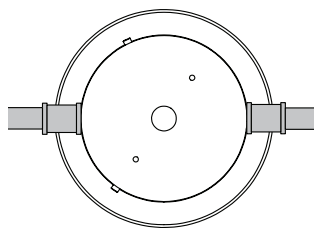

RC3 – two feeds for 90° wire turns.

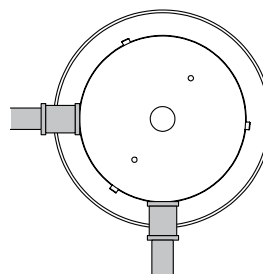

RCO - SURFACE MOUNT

Driver canopy and wireway mounts directly to ceiling.

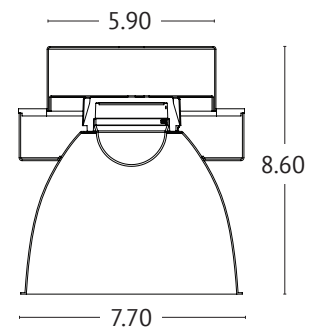

EMERGENCY

Specify **EM**. Battery pack provides 10W for 90 minutes. Mounted remote, with test switch and charge indicator light. Accessible through remote box door.

Voltage must be specified.

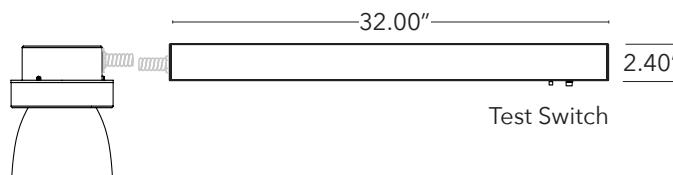

RADAR

surface LED downlight with optional accent uplight



WHITE LEDS

LED modules feature opal diffuser that provide the appearance on an A-lamp from below. Specify color: **W30**–3000°, **W35**–3500°, or **W40**–4000° Kelvin. CRI = 92, R9 = 72.

CUSTOM LUMEN OUTPUT REDUCTION

Factory set custom reduced-lumen output driver configuration. Specify lumens.

COLOR LEDS

Uplight is **RGBW** with 3500°K white LEDs. **CT** downlight uses Lumenetix-araya™ Entertainment LED module 1650-8000°K white tunable range, 90+ CRI, with red, green, blue, amber, mint, and cyan chips. See <https://www.erp-power.com/our-products/tunable-color-lumenetix-araya/> for details. Includes dimming interface. Optional DMX controller also available (See below.)

DIMMING

- **D**—standard supplied driver. 0–10V, programmable, 1% dimming, 120/277V, 50/60 Hz.
- **BDIM-W11**—Lutron EcoSystem LED14 Series, 1% dimming, fade-to-off.
- **DPH**—Triac and ELV 1% dimming at 120V 60 Hz only.
- **DA**—DALI 1% dimming, fade-to-off. 120/277V, 50/60 Hz.
- **DMX**—for both white and **RGBW/CT** LEDs, 0.1% dimming fade-to-off. 120/277V 50/60Hz

EMERGENCY

Emergency Battery Pack provides 10W for 90 minutes. Mounted remote, with test switch and charge indicator light. Accessible through remote box door. Order **EM**. Voltage must be specified.

WATTS / DELIVERED LUMENS

MODEL	WATTS	DELIVERED LUMENS	MODEL	WATTS	DELIVERED LUMENS
IL7600 LO (white)	22	2,000	IL7600 CT downlight	39	N/A
IL7600 MO (white)	33	3,000	IL7600 RGBW uplight	6	N/A
IL7600 HO (white)	44	4,000	IL7600 uplight (white)	9	N/A

DOWNLIGHT CP DISTRIBUTION

22W shown

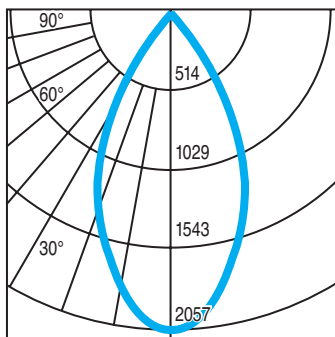

DOWNLIGHT COEFFICIENTS

22W shown

% CEILING 80 (20% FLOOR)

% WALL	70	50	30
0	119	119	119
1	114	111	109
2	108	103	100
3	103	97	92
4	98	91	85
5	93	85	79
6	89	80	74
7	85	76	70
8	81	72	66
9	77	68	62
10	74	64	59

REMOTE DRIVERS

For suspended and hard lid ceilings with access panels. Must be accessible after installation. **TB**—T-bar installation shown. Order **RR**.

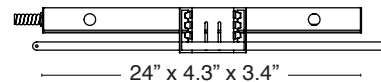

Max. Wiring Distance (at full load)

Wire Size (AWG)	Distance (ft.)
18	18
16	29
14	46
12	71
10	120

NOTE: Multiple drivers must be mounted no less than four in. apart side-by-side, and one inch apart end-to-end, to prevent overheating.

OPTIONAL DMX CONTROLLER

- Standalone, wall-mounted DMX controller for **RGBW/CT** LEDs that provides direct access to fixtures. Power supply included.
 - Tune color hue with sensitive wheel. Saturation and brightness control. On/off switch.
 - Go to <https://www.nicolaudie.com/en/stick-de3.htm> for details.
- Order separately, either **BDMXCON-W**—white faceplate or **BDMXCON-B**—black faceplate.

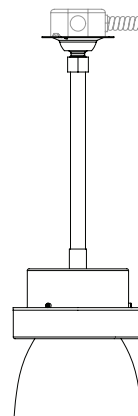

OPTIONAL PIPE MOUNT

- **CM1**—1/2" trade size pipe mount, supplied with swivel canopy for earthquake code, sloped ceilings, and indoor areas with light air movement (e.g., near HVAC vents).
- Pipe replaces power cord and cable. Specify length.
- Pipe longer than 8 ft. will be shipped in two sections—one 8 ft., the other for the balance—with painted, threaded pipe coupler and set screws.



FEB 2022