

UNO chandeliers

direct circular LED pendants with acrylic lens



CONSTRUCTION

- Extruded aluminum outer housing
- Direct frosted acrylic lenses.
- Suspended with field-adjustable aircraft cable, with push-button glider. 8 ft. 18 AWG power cord. Push button grippers supplied, standard. Specify **XP** for additional length. (25 ft. maximum.)
- Default finish/power cord pairings are silver/gray, white/white, black/

black.

- For RAL colors, power cord color must be specified.
- For differing fixture/canopy colors, please consult factory.
- Drivers and DMX module remotely installed in surface mount canopy. For remote driver installation, see page 2.
- Drivers are universal voltage (120–277V).

- Nominal diameters, right. For actual diameters (in.), see chart p. 2.
- ETL listed per UL and CSA standards.

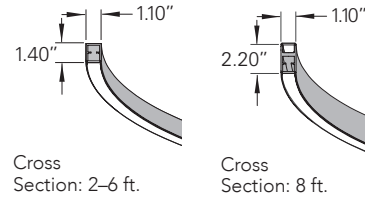

TYPE:	PROJECT:
ORDER NUMBER:	

MODEL#	SIZE	FINISH			LEDS	DIMMING	OPTION
UCG Gyroscope	2 ft.	S -Silver	BW -Barn Wood	SD -Silver Driftwood	W30	D -Standard	SS
UCN Nexus	3 ft.	W -White	CB -Carbon Fiber	DC -Dark Cherry	W35	BDIM-W11	EM
UCC Cascade	4 ft.	K -Black	ES -Espresso	KL -Khaki Leather	W40	DMX	
	5 ft.	CC -RAL Color*	HK -Honey Oak	(More see p. 3)	RGBW -color +	DA -DALI	
	6 ft.		M -Maple		3500° K white		
	8 ft.						

Example:

UCG	4/6/8	CB	W35	D	SS
------------	--------------	-----------	------------	----------	-----------

BDMXCON-W - white faceplate (enter quantity):		XP - Extra power cord (in inches, 25 ft. max.):	
BDMXCON-B - black faceplate (enter quantity):		Specify canopy finish (silver, white, black):	
EB - Earthquake Bracing Kit (enter quantity):		Specify power cord color (gray, white, black):	
XL - custom lumen reduction (specify lumens):		*Specify RAL color number:	

* 8 ft. utilizes Dos extrusion; shipped in two sections, with joiners, for assembly in the field.

UCG—Uno Gyroscope,
Central Remote mount
Choose up to three: 2/3/4/5/6/8 ft.

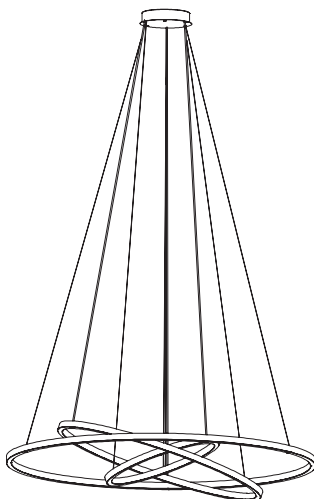

UCN—Uno Nexus,
Central Remote mount
Choose up to three: 2/3/4/5/6/8 ft.

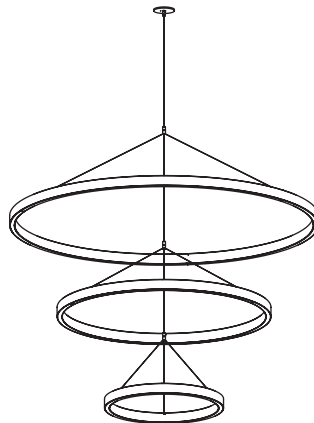

UCC—Uno Cascade,
Separate Remote mount
Choose up to three: 2/3/4/5/6/8 ft.

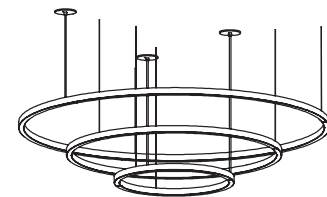

Note: Drawings indicate mount style only. Stacks and gyroscopes are configured in the field by adjusting aircraft and power cable lengths.

UNO chandeliers

direct circular LED pendants with acrylic lens



WHITE LEDS

Nichia Corp. NFSL757 tight bin chips on aluminum boards. 90 CRI. Specify color: W30–3000° Kelvin, W35–3500° Kelvin, or W40–4000° Kelvin.

CUSTOM LUMEN OUTPUT REDUCTION

Factory set custom reduced-lumen output driver configuration. Order **XL**. Specify lumens. Static white only.

COLOR LEDS

RGBW with 3500° K white. Includes RGBW interface. Optional DMX controller also available. (See below.)

DIMMING

- **D**—standard supplied driver. 0–10V, programmable, 1% dimming, 120/277V, 50/60 Hz.
- **BDIM-W11**—Lutron EcoSystem LED14 Series, 1% dimming, fade-to-off. Remote (**SR, CR, NCR**) install only.
- **DA**—DALI 1% dimming, fade-to-off. 120–277V, 50/60 Hz.
- **DMX**—for both white and RGBW LEDs, 0.1% dimming fade-to-off. 120–277V, 50/60Hz.

DIAMETER / WATTS / LUMENS / DRIVERS REQUIRED / WEIGHT

DIAMETER Nominal (Actual)	WATTS		DELIVERED LUMENS		DRIVERS REQUIRED		WEIGHT (lb.)
	White	RGBW	White	RGBW	White	RGBW	
2 ft. (25.10 in.)	26	Consult Factory	2,166	Consult Factory	1	Consult Factory	7
3 ft. (35.10 in.)	39		3,250		1		14
4 ft. (45.10 in.)	52		4,333		2		16
5 ft. (65.10 in.)	65		5,416		2		18
6 ft. (80.10 in.)	78		6,500		2		20
8 ft. (95.10 in.)	104		8,666		2		30

REMOTE DRIVERS

Drivers must be reomote. For suspended and hard lid ceilings with access panels. Canopy mounts to mud ring attached to J-box. Must be accessible after installation.

NOTE: Multiple drivers must be mounted no less than four inches apart side-by-side, and one inch apart end-to-end, to prevent overheating.

Standard pendant length: 8 ft. Specify **XP** for extra pendant. Maximum canopy to fixture distance: 25 ft. Maximum canopy to driver distance: 100 ft. (with 10 AWG wire).



Remote Driver Canopy
3.80 x 0.45 in.

UDCN, UDCC – separate mount driver installation.

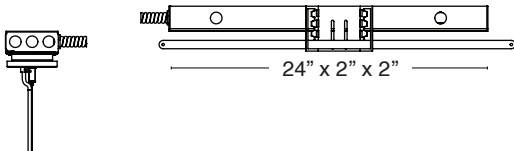

UDCG – central mount remote driver installation.

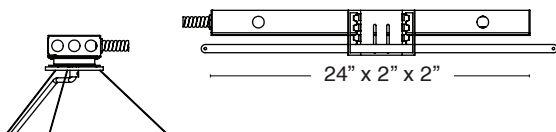

AIRCRAFT CABLE

NOTE: Not recommended for outdoor use, where fixture will be exposed to water, or subject to wind oscillation. Avoid use near HVAC vents and in environments with corrosive chemical vapors, such as swimming pools.

EM – Emergency. T-bar install shown, below. Battery pack provides 10W for 90 minutes. Remote install only. Red driver light and test switch mounted in handy box installed at ceiling.

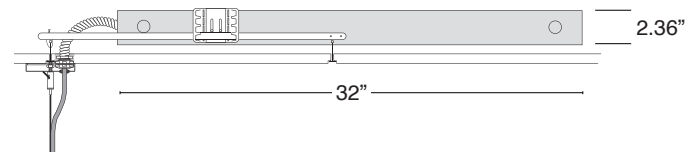

OPTIONAL DMX CONTROLLER

- Standalone, wall-mounted DMX controller for RGBW LED that provides direct access to fixtures. Power supply included.
 - Tune color hue with sensitive wheel. Saturation and brightness control. On/off switch.
 - See <https://www.nicolaudie.com/en/stick-de3.htm> for details.
- Order separately, either **BDMXCON-W**—white faceplate or **BDMXCON-B**—black faceplate.

JOINER

8 ft. rings only. Joins two sections in the field.

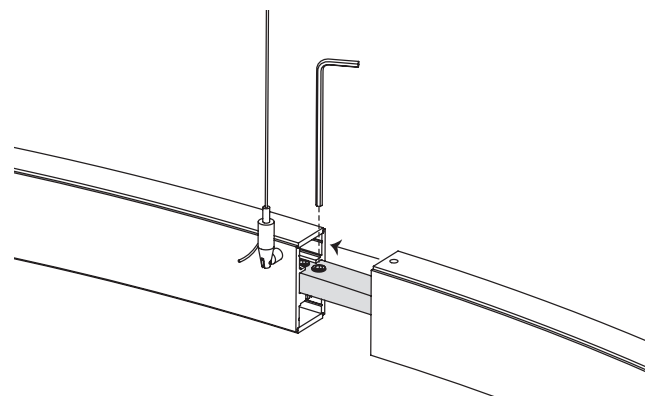

UNO chandeliers

direct circular LED pendants with acrylic lens



PAINT FINISHES

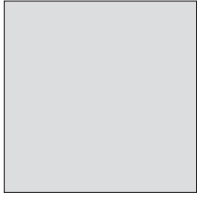

S-Silver

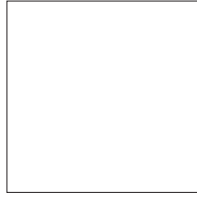

W-white



K-Black

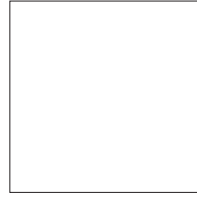

CC-XXXX RAL Color

TEXTURED FINISHES



BW-Barnwood

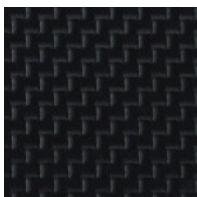

CB-Carbon Fiber



ES-Espresso



HK-Honey Oak



M-Maple



SD-Silver Driftwood

PREMIUM TEXTURED FINISHES



DC-Dark Cherry

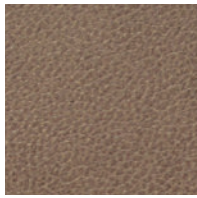

KL-Khaki Leather

METALLIC FINISHES

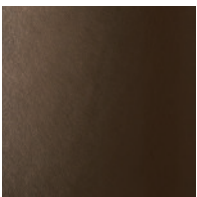

BR-Bronze



GF-Gold Leaf



CO-Copper

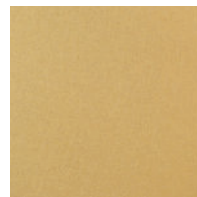

GT-Gold Textured

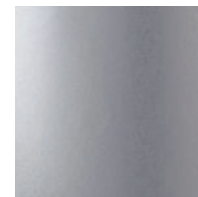

SA-Stainless Steel

TEXTURED FINISHES - CANOPY AND POWER CORD COLORS

Specify Silver, White, Black or RAL color for canopy.
Also specify Gray, White or Black power cord.

ACRYLIC DIFFUSER CLEANING

WARNING: Do not clean with ammonia based cleaners (e.g. Windex®). Use only water or cleaners specifically formulated for cleaning plastics.