

Stick SLT9 trim 20

adjustable LED single lamp cantilever with square trim and white louvers

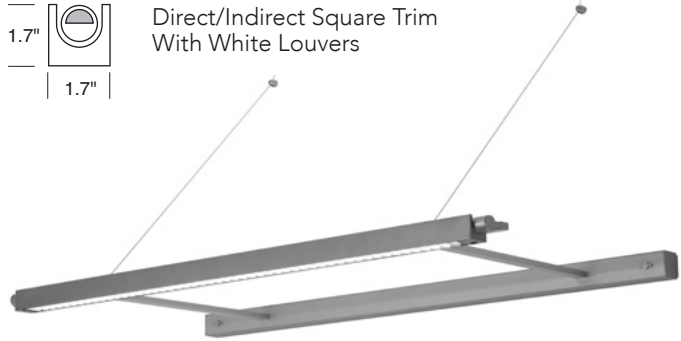

CONSTRUCTION

- o Single 2, 3 and 4 ft., or double 6 and 8 ft., wall mount, cantilevered fixture that may be installed stand-alone or in continuous runs. Mounted to continuous wireway and driver housing Rail System.
- o The back plate has a 7/8" opening for direct conduit power feed at the end caps, or from anywhere along the Rail housing.
- o Projections are available in lengths of 6, 12, 18 and 24 inches, standard. Also available in custom lengths (specify).
- o Projections over 12 inches require aircraft cable support (4 ft. cable and angle-adjusting cable grippers supplied).
- o cUL listed for damp locations..

TYPE:	PROJECT:
ORDER NUMBER:	

MODEL#	LENGTH (ft.)	PROJECTION (inches)	HO/LO	LEDS	DIMMING	EMERGENCY	OPTION	TRIM
SLT9 - Stand-Alone	8	6	LO	W30	D-Standard	EM -Emergency	SRB9S	20
SLTR9 - Right	6	12	HO	W35	BDIM-W11		SRB9R	
SLTM9 - Middle	4	18		W40				
SLTL9 - Left	3	24						
	2							
Example:								
SLT9	8		HO	W35	D		SRB9S	20

Custom Projection (in inches):		XL- custom lumen reduction (specify lumens):	
Run Length (total feet):			

MODEL
SLT98LO/HO
SLT96LO/HO

LENGTH
8 ft.
6 ft.

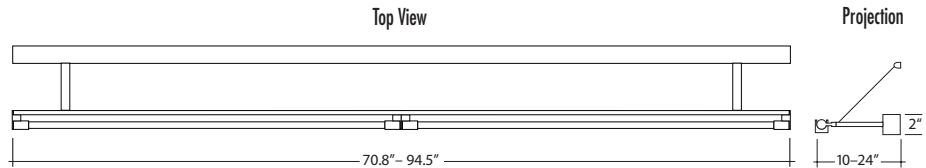

MODEL
SLT94LO/HO
SLT93LO/HO
SLT92LO/HO

LENGTH
4 ft.
3 ft.
2 ft.

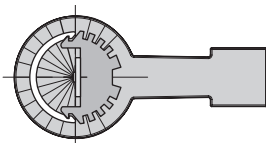
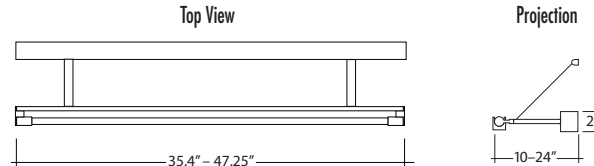

Lamp rotates 270°, in 15° stepped increments, to direct light where needed.

Stick SLT9 trim 20

adjustable LED single lamp cantilever with square trim and white louvers



WHITE LEDS

Samsung tight bin chips on aluminum clad boards. 90 CRI. Specify color: W30–3000° Kelvin, W35–3500° Kelvin, or W40–4000° Kelvin color temperature.

DIMMING

- **D**—standard supplied driver. 0–10V, programmable, 1% dimming, 120/277V, 50/60 Hz.
- **BDIM-W11**—Lutron EcoSystem LED14 Series, 1% dimming, fade-to-off.

EMERGENCY

For 4' through 8' fixtures only. Battery pack provides 10W for 90 minutes. Adds additional length to driver housing.

CUSTOM LUMEN OUTPUT REDUCTION

Factory set custom reduced-lumen output driver configuration. Order **XL**. Specify lumens.

WATTS / LUMENS / EFFICACY

LENGTH	WATTS	DELIVERED LUMENS	EFFICACY
2 ft. LO	7	722	97 LPW
2 ft. HO	14	1,443	97 LPW
3 ft. LO	10.5	1,082	97 LPW
3 ft. HO	21	2,165	97 LPW
4 ft. LO	14	1,443	97 LPW
4 ft. HO	28	2,886	97 LPW

AIRCRAFT CABLE

NOTE: Not recommended for outdoor use, where fixture will be exposed to water. Avoid use in environments with corrosive chemical vapors, such as swimming pools.

CONNECTING SECTIONS

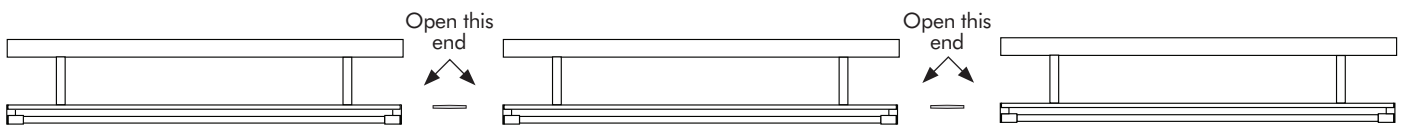

RIGHT

SLTR open on right end

	LENGTH
SLTR98LO/HO	8 ft.
SLTR96LO/HO	6 ft.
SLTR94LO/HO	4 ft.
SLTR93LO/HO	3 ft.
SLTR92LO/HO	2 ft.

MIDDLE

SLTM open on both ends

	LENGTH
SLTM98LO/HO	8 ft.
SLTM96LO/HO	6 ft.
SLTM94LO/HO	4 ft.
SLTM93LO/HO	3 ft.
SLTM92LO/HO	2 ft.

LEFT

SLTL open on left end

	LENGTH
SLTL98LO/HO	8 ft.
SLTL96LO/HO	6 ft.
SLTL94LO/HO	4 ft.
SLTL93LO/HO	3 ft.
SLTL92LO/HO	2 ft.

CONTINUOUS RUN CONNECTION

Follow instructions for rail or remote driver installation. Be certain to join right, left and middle fixtures accordingly. Slide connector to ensure proper alignment of adjacent fixtures. **Does not connect stand-alone fixtures.**

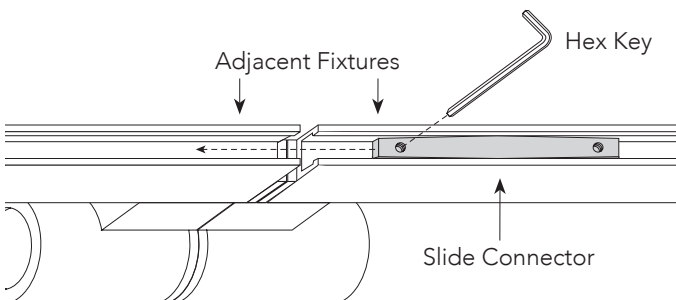

SRB OPTION

Make lamp wire connections in a horizontally mounted 2x4 handy box. Driver must be accessible after installation. Maximum canopy to driver distance: 100 ft. (with 10 AWG wire).

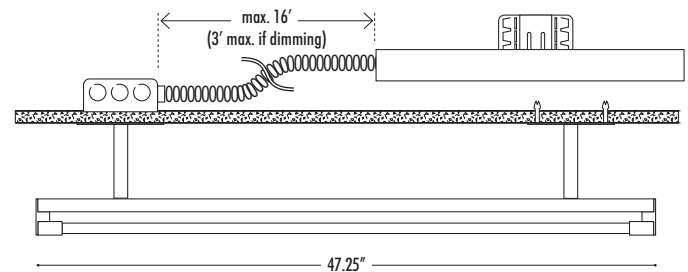

NOTE: Multiple drivers must be mounted no less than 4 in. apart side-by-side, and 1 in. apart end-to-end, to avoid overheating.

SRB9S – 2x4 in. rectangular cover plates that mount directly to standard handy boxes.

SRB9R – 4 in. round cover plates that mount to standard mud rings.

