

Stick SLT6 trim 18

rail mount adjustable LED pendant with perforated white reflector

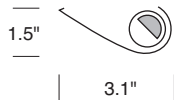
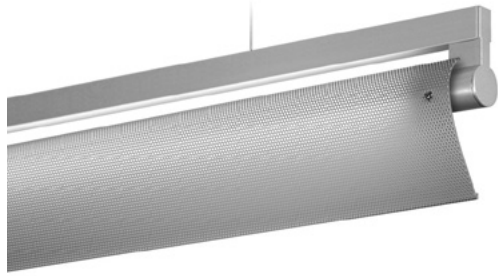

TRIM 18
Fully Perforated White Reflector with Acrylic Backing

CONSTRUCTION

- Single 2, 3, 4 ft. or dual lamp 6 or 8 ft. inline pendant fixture, which mounts to an extruded aluminum continuous wireway and driver housing Rail System.
- Designed for open ceiling environments, the Rail System may be mounted directly to ceilings, joists, or decks; replacing J-box and conduit, for a cleaner appearance. The back plate has a 7/8" opening for direct conduit power feed at the end caps, or from anywhere along the Rail housing.
- Rail System housing may also be suspended as a pendant. 8 ft. gray adjustable power and aircraft cables, with push button grippers supplied, standard.
- Specify XP for additional length (25 ft. max.).
- cUL listed for damp locations.

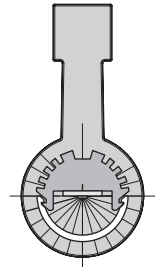

Lamp rotates 270°, in 15° stepped increments, to direct light where needed.

TYPE:	PROJECT:
ORDER NUMBER:	

MODEL#	LENGTH (FT.)	HO/LO	LEDS	DIMMING	EMERGENCY	TRIM
SLT6- Stand-Alone	8	LO	W30	D-Standard	EM-Emergency	18
SLTR6- Right	6	HO	W35	BDIM-W11		
SLTM6- Middle	4		W40			
SLTL6- Left	3					
	2					
Example:						
SLT6	8	HO	W35	D		18

XP -Extra power cord (in inches, 25 ft. max.):	XL -custom lumen reduction (specify lumens):
Run Length (total feet):	

MODEL	LENGTH
SLT68LO/HO	8 ft.
SLT66LO/HO	6 ft.

*Rail Parts ordered separately.

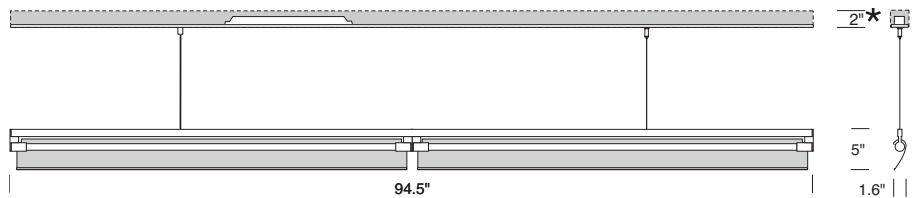

MODEL	LENGTH
SLT64LO/HO	4 ft.
SLT63LO/HO	3 ft.
SLT62LO/HO	2 ft.

*Rail Parts ordered separately.

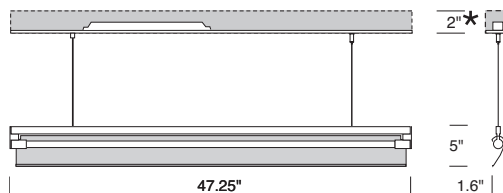

Stick SLT6 trim 18

rail mount adjustable LED pendant with perforated white reflector



WHITE LEDS

Samsung tight bin chips on aluminum clad boards. 90 CRI. Specify color: W30–3000° Kelvin, W35–3500° Kelvin, or W40–4000° Kelvin color temperature.

DIMMING

- **D**—standard supplied driver. 0–10V, programmable, 1% dimming, 120/277V, 50/60 Hz.
- **BDIM-W11**—Lutron EcoSystem LED14 Series, 1% dimming, fade-to-off.

CUSTOM LUMEN OUTPUT REDUCTION

Factory set custom reduced-lumen output driver configuration. Order **XL**. Specify lumens.

EMERGENCY

For 4' through 8' fixtures only. Battery pack provides 10W for 90 minutes. Adds additional length to driver housing.

WATTS / LUMENS / EFFICACY

LENGTH	WATTS	DELIVERED LUMENS	EFFICACY
2 ft. LO	7	722	97 LPW
2 ft. HO	14	1,443	97 LPW
3 ft. LO	10.5	1,082	97 LPW
3 ft. HO	21	2,165	97 LPW
4 ft. LO	14	1,443	97 LPW
4 ft. HO	28	2,886	97 LPW

AIRCRAFT CABLE

NOTE: Not recommended for outdoor use, where fixture will be exposed to water, or subject to wind oscillation. Avoid use near HVAC vents and in environments with corrosive chemical vapors, such as swimming pools.

CONNECTING SECTIONS

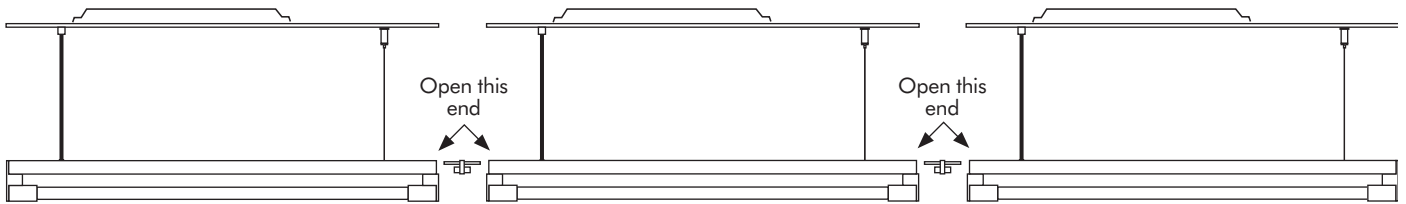

RIGHT

SLTR open on right side of cord

	LENGTH
SLTR68LO/HO	8 ft.
SLTR66LO/HO	6 ft.
SLTR64LO/HO	4 ft.
SLTR63LO/HO	3 ft.
SLTR62LO/HO	2 ft.

MIDDLE

SLTM open on both ends

	LENGTH
SLTM68LO/HO	8 ft.
SLTM66LO/HO	6 ft.
SLTM64LO/HO	4 ft.
SLTM63LO/HO	3 ft.
SLTM62LO/HO	2 ft.

LEFT

SLTL open on left side of cord

	LENGTH
SLTL68LO/HO	8 ft.
SLTL66LO/HO	6 ft.
SLTL64LO/HO	4 ft.
SLTL63LO/HO	3 ft.
SLTL62LO/HO	2 ft.

CONTINUOUS RUN CONNECTION

STJR—creates a mechanical connection for continuous runs. One connector is included with each two connecting fixtures.

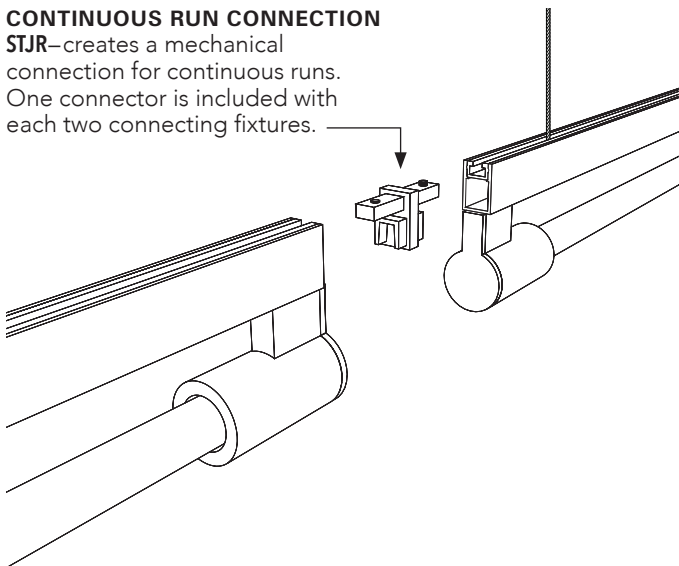

RAIL SYSTEM

