

WARNING: disconnect main power at the source prior to installation! *Only qualified electricians should install Delray Lighting products.*

Standard Surface Mount Canopy

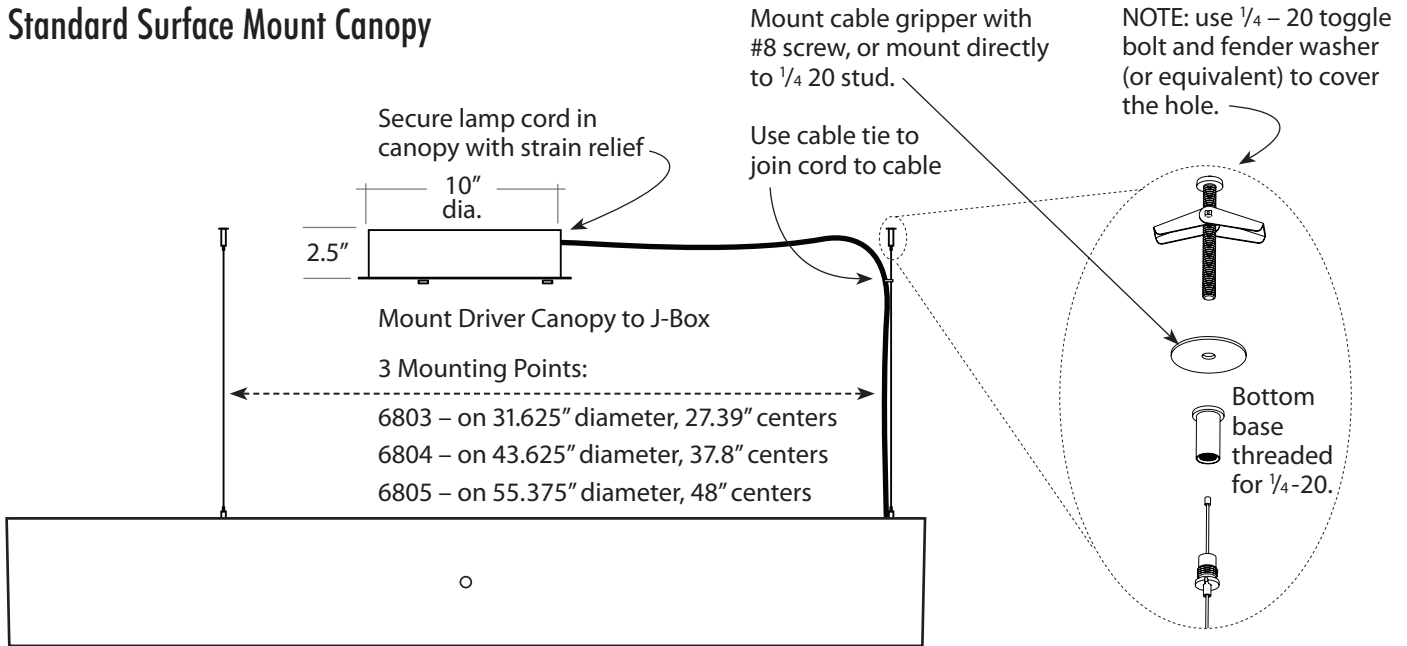

SLRD Option Remote Driver

Remote driver housing must remain accessible. Use bar hangers to mount in ceiling.

*Max. Wiring Distance (at full load)

Wire Size (AWG)	Distance (ft.)
18	18
16	29
14	46
12	71
10	120

NOTE: multiple drivers must be mounted no less than 4 inches apart side-by-side, and 1 inch apart end-to-end, to avoid overheating.

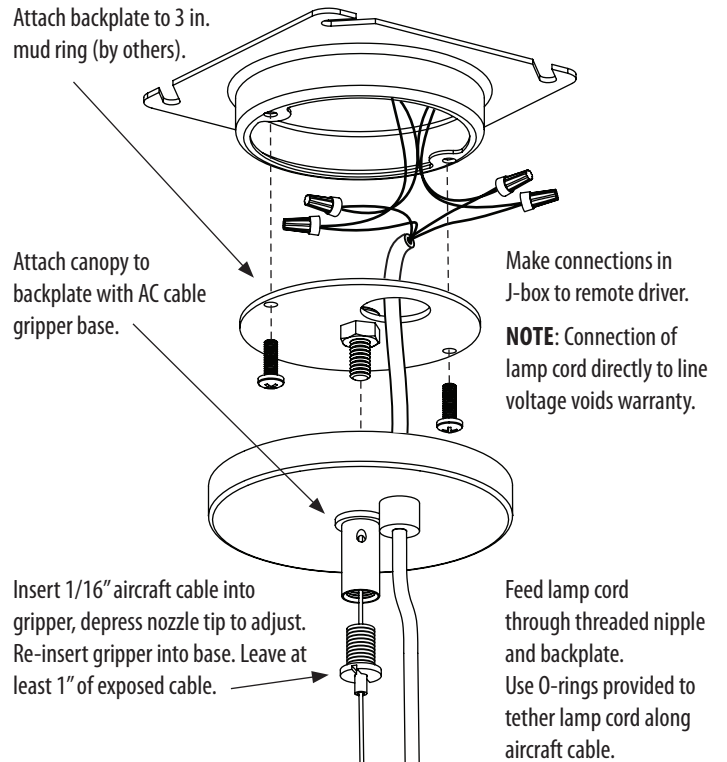
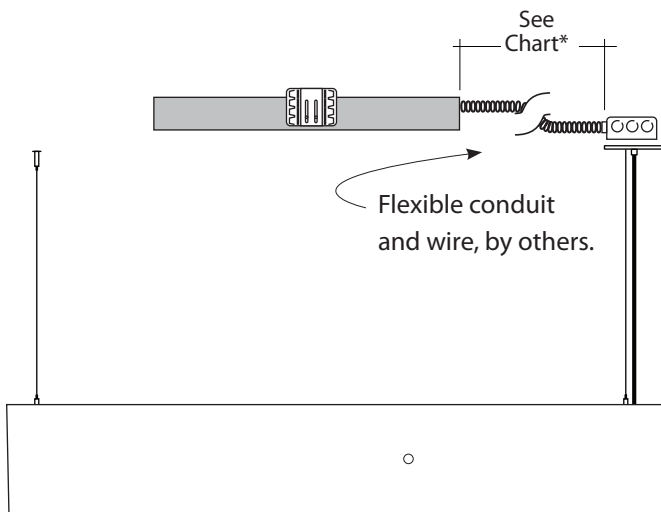

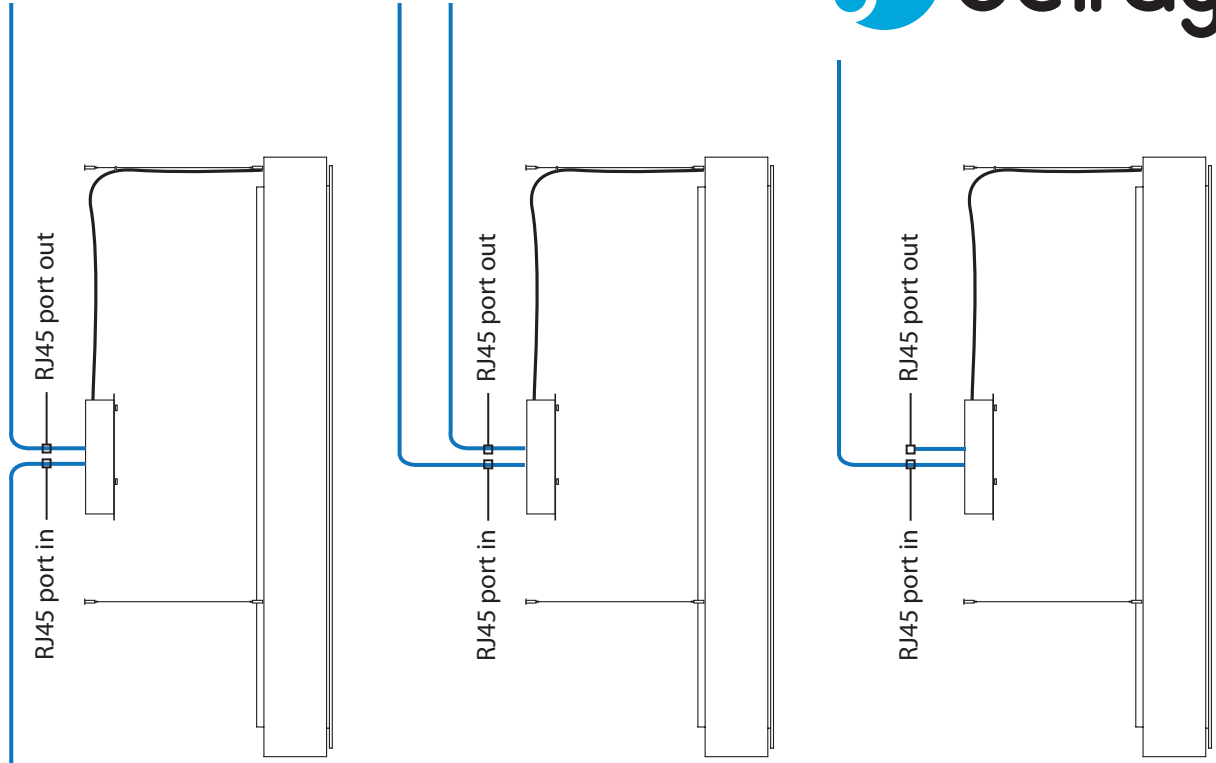

Traxon
DMX controller

CAT5e or CAT6 cable, 568B
color code

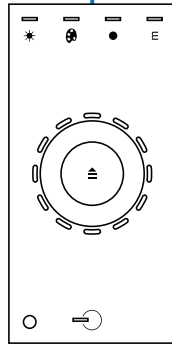

Cylindro II & III fixtures are prewired to accept CAT5e cable. Up to 31 fixtures may be controlled in a single zone. The control wire (CAT5e cable) must daisy chain to each driver housing for proper control.



For proper operation, confirm that the interface PWM dials remain on the factory preset of channel 1 (001), on all control interfaces, in all fixture driver housings connected to the Traxon controller.

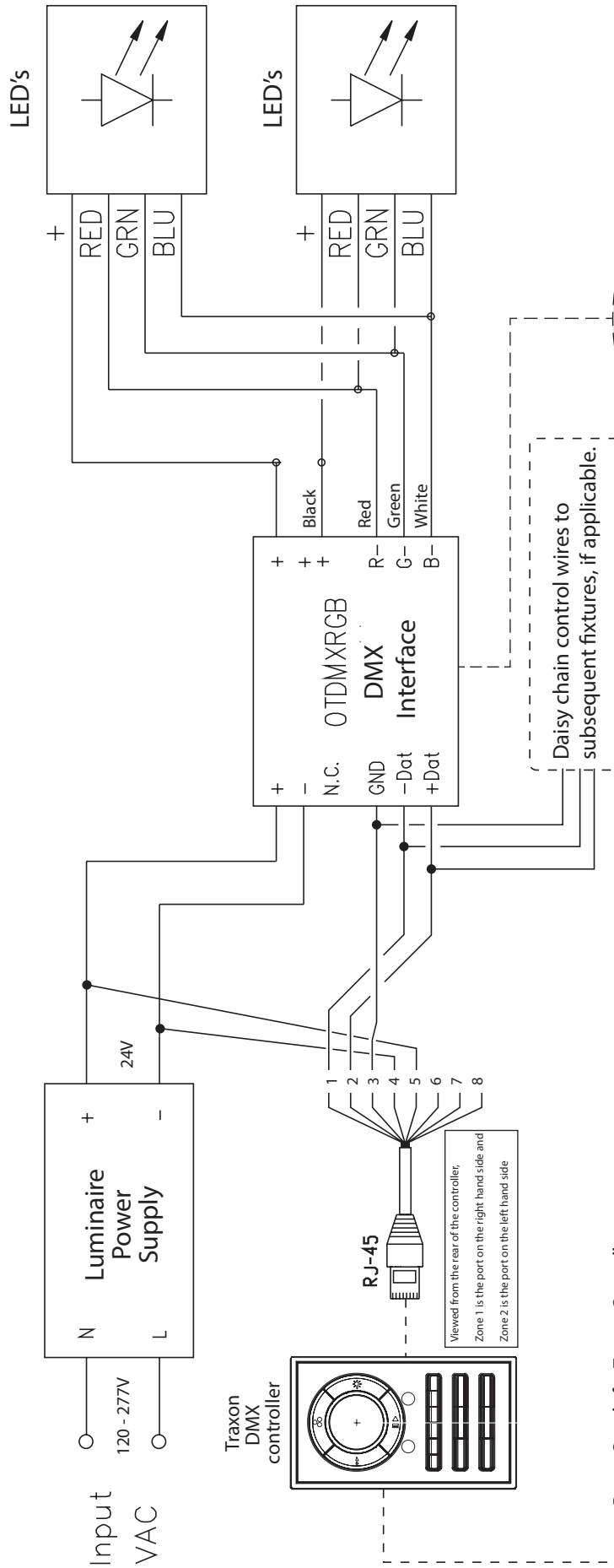

Power Supply for Traxon Controller

The unit is powered by an external PSU running at 24 VDC. Power is only supplied via the RJ45 port. The fixtures power supply is prewired for this.

The PIN assignment of the two DMX outputs (female RJ45 ports) is as follows:

Typical 568B color code (verify)	1	2	3	4	5	6	7	8
white/orange	DMX -	DMX +	GND	Power GND	No function	No function	No function	No function
orange								
white/green								
blue								
white/blue								
green								
white/brown								
brown								

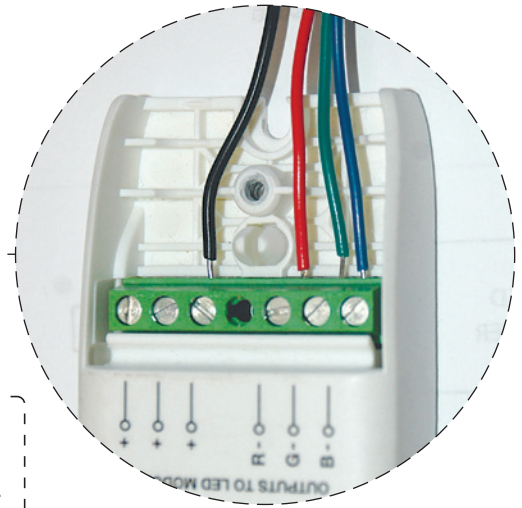
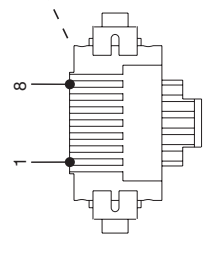

NOTE: If all colors are not working, check the output side of the DMX interface for loose connections. If the connections are good, then check the connector on the LED strip inside the fixture.

WARNING: Disconnect main power at the source prior to installation!

Fixture must be installed by a qualified electrician.

With Integrated Dimming

Single Driver

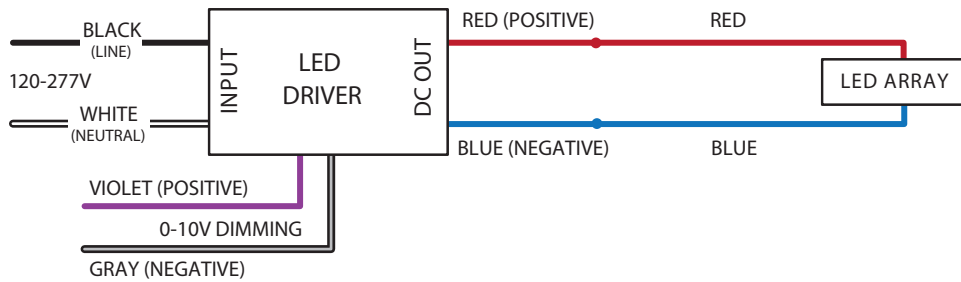

Dual Driver*

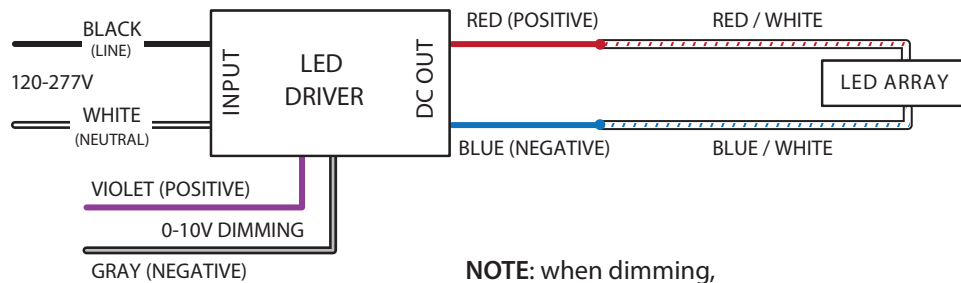

NOTE: when dimming, use low end trim pot, and adjust low end to above flicker threshold.

* If no dimming, cap wires.

WARNING Risk of fire or electric shock. Only qualified, licensed electricians should install Delray Lighting products.

1. Read and review all instructions and diagrams prior to installation.
2. Disconnect power prior to installation. Turn off circuit breaker or remove fuse from fuse panel. (Turning off the light switch is insufficient to safeguard against electric shock.)
3. Electrical connections must conform to local codes and ordinances, or the National Electrical Code.
4. Wire the luminaire following the wiring diagram on the ballast, or inside the box. Use UL listed wire connectors suitable for the size, type, and number of conductors. No loose strands or wires should be present. Secure wire connectors with UL listed electrical tape and wire nuts.

5. Install lamps (not included). Do not exceed recommended wattage.
6. Restore electricity and test fixture.

NOTE: These safeguards and instructions are not intended to cover all possible conditions and circumstances. Proceed with caution; utilizing established professional electrical installation methods, tools, and supplies.