

UNO CIRCULAR DIRECT LED WITH OPAL ACRYLIC LENS

DELRAY
LIGHTING
INCORPORATED

UNO CIRCULAR LED. DIRECT

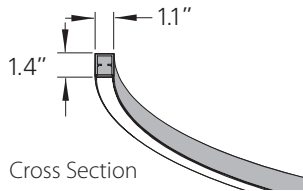
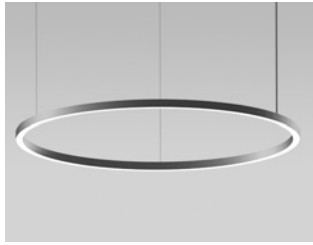

CONSTRUCTION

- Extruded aluminum outer housing with direct white frosted acrylic diffuser. 8 ft. gray or white 18 AWG adjustable power cord and AC cables with push button grippers supplied, standard. Specify **XP** for additional length (25 ft. max.).

WHITE LEDs

- Nichia Corp. NFSL757 tight bin chips on aluminum clad boards. 90 CRI.
- W30** (3000K), **W35** (3500K), and **W40** (4000K) white color temperatures.
- Drivers are programmable constant current, 0-10V, 1% dimming, standard.

CUSTOM LUMEN OUTPUT REDUCTION

- Factory set custom reduced-lumen output driver configuration. Order **XL**. Specify lumens.

COLOR LEDs

- Red, Blue or **SQ**-RGB flexible 5050 tapelights.
- Constant voltage drivers are 12V for single color, 24V for RGB sequencer.
- RGB sequencer requires **BDMXMOD** DMX 512 interface.
- Optional DMX wall box control offered separately (see Traxon, page 2.)

STANDARD CANOPY

- Drivers and DMX module installed in surface mount canopy. For remote driver installation, see page 2.
- cUL listed for dry locations only.
- Specify:
 - S, CS**-standard canopy (10" x 2.25") Mounts to all standard J-boxes.
 - SR, CR, NCR**-remote canopy (3" x 0.45") Mounts to 3" mudring.

TYPE:

PROJECT:

ORDER NUMBER:

Model#	Finish	LEDs	Mount	Option
UC2 -2 ft.	S -Silver	W30	S -Separate	BDIM-W9
UC3 -3 ft.	W -White	W35	SR -Separate Remote	BDIM-W11
UC4 -4 ft.	K -Black	W40	CS -Central Standard	BDMXMOD
UC5 -5 ft.		Red	CR -Central Remote	
		Blue	NCR -Nexus CR	
		SQ -RGB	SREM -Separate EM	
			CREM -Central EM	

Example:

UC5	S	W40	SR	BDIM-W9
-----	---	-----	----	---------

- BTRAXW**-Traxon Light Drive (enter quantity): _____
- XP**-Extra power cord (in inches; max. 25 ft.): _____
- RBRD**-red braided cord (in inches; max. 25 ft.): _____

- UC2** - 2 ft.
- UC3** - 3 ft.
- UC4** - 4 ft.
- UC5** - 5 ft.

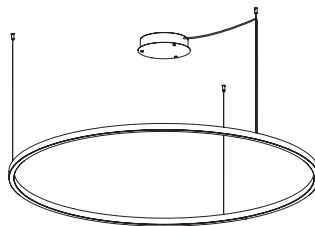

S - Separate

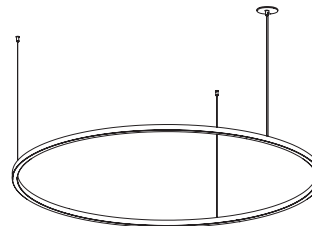

SR - Separate Remote

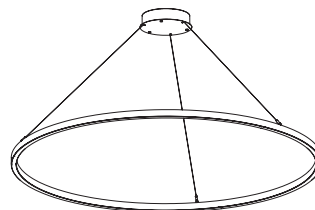

CS - Central Standard

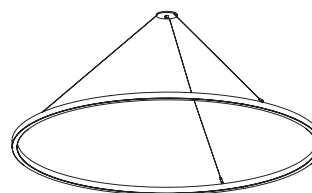

CR - Central Remote

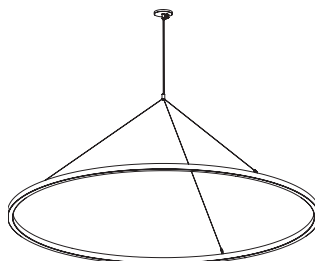

NCR - Nexus Central Remote

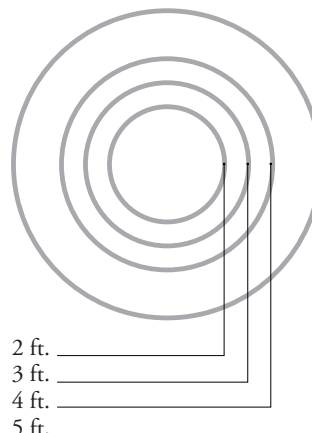

BURBANK,
CALIFORNIA,
91505
WWW.
DELRAY
LIGHTING.
COM

5 FT. LED

UC5.W35

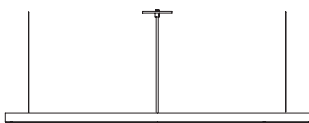

CP DISTRIBUTION

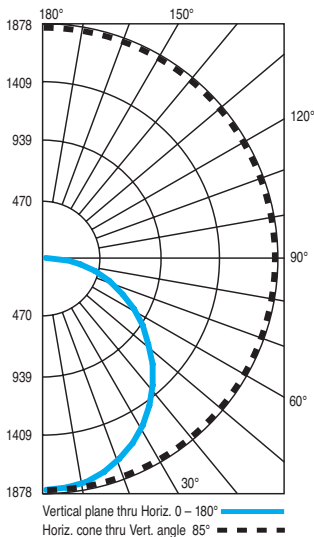

COEFFICIENTS

% CEILING 80	% (20% FLOOR)		
	70	50	30
0	119	119	119
1	108	103	98
2	98	89	82
3	89	78	70
4	82	69	60
5	75	62	53
6	69	56	47
7	64	50	42
8	60	46	37
9	56	42	34
10	52	39	31

NOTES

UC5.W35

59W LEDs, 3500°K
 Delivered lumens: 5,400

CRI: 90
 R9 ≥ 72

UNO CIRCULAR DIRECT REMOTE DRIVERS

Driver must be accessible after installation. For suspended and hard lid ceilings with access panels. Canopy mounts to mud ring attached to J-box.

Standard pendant length: 8 ft. Specify **XP** for extra pendant.
 Maximum canopy to fixture distance: 25 ft. Maximum canopy to driver distance: 100 ft. (with 10 AWG wire).

NOTE: Multiple drivers must be mounted no less than 4 inches apart side-by-side, and 1 inch apart end-to-end, to avoid overheating.

 Remote Driver Canopy
 3.8 x 0.45 in.

SR – Separate mount driver installation.

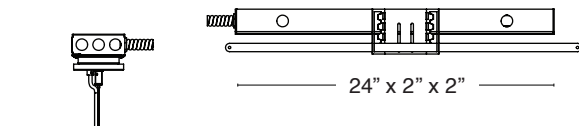

CR – Central mount remote driver installation.

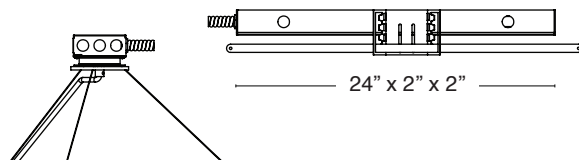

SR or **CR** – Separate or Central Emergency. *T-bar install shown, below.*

Emergency battery pack provides 7W for 90 minutes. (12W also available.)
 Remote install only. Red driver light and test switch mounted in handy box installed at ceiling.

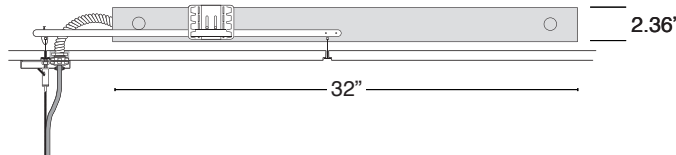

WATTS / LUMENS

Diameter	Watts	Total Lumens	Delivered Lumens
2'	23	4,100	2,166
3'	35	6,100	3,250
4'	47	8,150	4,333
5'	59	10,200	5,416

AIRCRAFT CABLE

Note: Aircraft cable suspension not recommended for outdoor use, where fixture will be exposed to water, or subject to wind oscillation. Avoid use near HVAC vents and in environments with corrosive chemical vapors, such as swimming pools.

ACRYLIC DIFFUSER CLEANING

Warning: Do not clean with ammonia based cleaners (e.g. Windex®). Use only water or cleaners specifically formulated for cleaning plastics.

OPTIONS

DIMMING DRIVERS

120/277V, 50/60 Hz.

STANDARD DIMMING

Programmable, 0–10V, dims to 1%.

LUTRON DIMMING DRIVERS

BDIM-W9

- Lutron Hi-Lume L3DA Series, 3-wire
- Dims to 1%

BDIM-W11

- Lutron EcoSystem LDE14 Series
- Dims to 1%
- Fade to off.

RGB OPTIONS

BDMXMOD

- Osram part no. OTDMXRGB supplied.
- DMX control interface for RGB LED.
- Provides DMX control with protocols that meet USITT DMX-512A or DMX512 (DIN 56930-2). No converter is required. DMX controls by others.
- A second 4-conductor control cable to fixture canopy is supplied.

TRAXON LIGHT-DRIVE RGB

(order separately)

BTRAXW – white faceplate

- Standalone, wall-mounted (12V power supply included) DMX controller for RGB LED that provides direct access to fixtures.
- Tune color and brightness with the Light-Drive wheel.
- Fully dimmable white mode button.
- See www.traxon-usa.com for details.

RED BRAIDED CORD

Red braided power cord.
 Order **RBRD**.

