

# UNO CIRCULAR INDIRECT LED WITH OPAL ACRYLIC LENS

**DELRAY**  
LIGHTING  
INCORPORATED

UNO 6'+8' CIRCLES. INDIRECT



**TYPE:**

**PROJECT:**

**ORDER NUMBER:**

Model#	Finish	LEDs	Mount	Option
UIC6-6 ft.	S-Silver	W30	S-Separate	BDIM-W11
UIC8-8 ft.	W-White	W35	SR-Sep. Remote	
	K-Black	W40	CS-Cen. Standard	
		Red	CR-Cen. Remote	
		Blue	NCR-Nexus CR	
		SQ-RGB	SREM-Separate EM	
			CREM-Central EM	

## CONSTRUCTION

- Extruded aluminum outer housing with direct white frosted acrylic diffuser. 8 ft. circles are shipped in two sections, with joiners for assembly in the field. Each fixture includes one 8 ft. gray or white 18 AWG adjustable power cord, plus two AC cables with push button grippers. Specify **XP** for additional length (25 ft. max.).

## WHITE LEDs

- Nichia Corp. NFSL757 tight bin chips on aluminum clad boards. 90 CRI.
- W30** (3000K), **W35** (3500K), and **W40** (4000K) white color temperatures.
- Drivers are programmable constant current, 0-10V, 1% dimming, standard. 6 ft. requires one driver. 8 ft. requires two drivers.

## CUSTOM LUMEN OUTPUT REDUCTION

- Factory set custom reduced-lumen output driver configuration. Order **XL**. Specify lumens.

## COLOR LEDs

- Red** and **Blue** are tapelight, using one 12V constant voltage driver. **SQ-RGB** are Nichia custom boards, using one 100W, 24V constant voltage driver and Eldo DMX interface.
- Optional DMX wall box control offered separately (see Traxon, page 2.)

## STANDARD CANOPY

- Mounts to all standard JBoxes.
- Drivers and DMX module installed in surface mount canopy. For remote driver installation, see page 2.
- cUL listed for dry locations only.
- Specify:
  - S, CS**-standard canopy (10" x 2.25")
  - SR, CR, NCR**-remote canopy (3" x 0.45")

**Example:**

UC8	S	W40	SR	BDIM-W11
-----	---	-----	----	----------

- BTRAXW**-Traxon Light Drive\* (enter quantity): \_\_\_\_\_
- XP**-Extra power cord (in inches; max. 25 ft.): \_\_\_\_\_
- XL**-custom lumen reduction (specify lumens): \_\_\_\_\_

UIC6 - 6 ft., 6,500 lumens, 70W  
UIC8 - 8 ft., 8,666 lumens, 94W

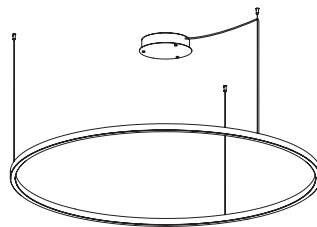
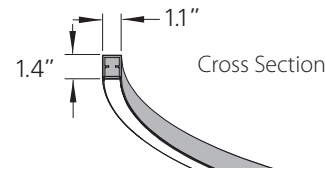

**S** - Separate

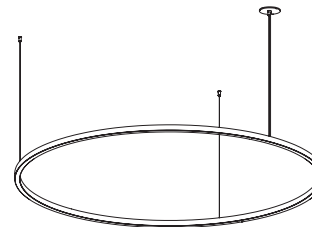

**SR** - Separate Remote

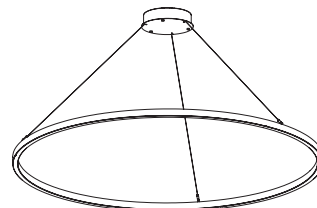

**CS** - Central Standard

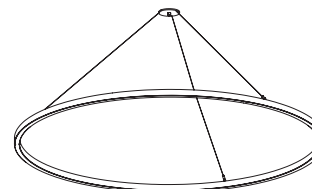

**CR** - Central Remote

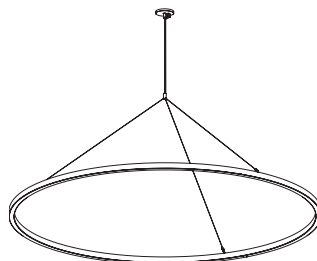

**NCR** - Nexus Central Remote

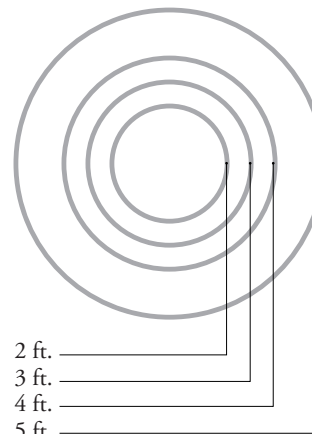

BURBANK,  
CALIFORNIA,  
91505  
WWW.  
DELRAY  
LIGHTING.  
COM

## 6 FT. LED

### UIC6.W35

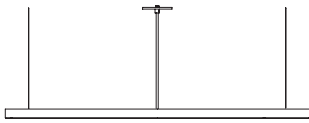

### CP DISTRIBUTION

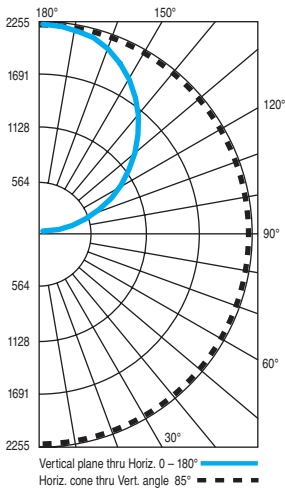

### COEFFICIENTS

% CEILING 80 % WALL 70	(20% FLOOR)	
	50	30
0	119	119
1	108	98
2	98	82
3	89	70
4	82	60
5	75	53
6	69	47
7	64	42
8	60	37
9	56	34
10	52	31

### NOTES

#### UIC6.W35

70W LEDs, 3500°K  
 Delivered lumens: 6,500

CRI: 90  
 R9 ≥ 72

## UNO 6/8 FT. CIRCULAR REMOTE DRIVERS

Driver must be accessible after installation. For suspended and hard lid ceilings with access panels. Canopy mounts to mud ring attached to J-box.

**NOTE:** Multiple drivers must be mounted no less than 4 inches apart side-by-side, and 1 inch apart end-to-end, to avoid overheating.

Standard pendant length: 8 ft. Specify **XP** for extra pendant.  
 Maximum canopy to fixture distance: 25 ft. Maximum canopy to driver distance: 100 ft. (with 10 AWG wire).

 Remote Driver Canopy  
 3.8 x 0.45 in.

**SR** – Separate mount driver installation.

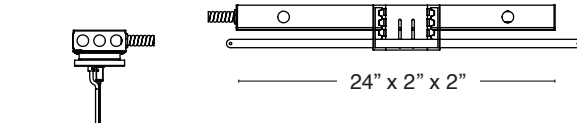

**CR** – Central mount remote driver installation.

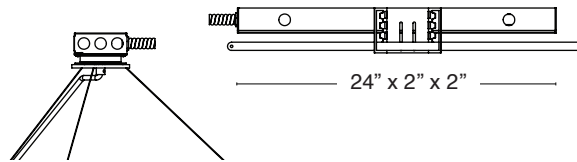

**SREM** or **CREM** – Separate or Central Emergency. *T-bar install shown, below.*

Emergency battery pack provides 7W for 90 minutes. (12W also available.)  
 Remote install only. Red driver light and test switch mounted in handy box installed at ceiling.

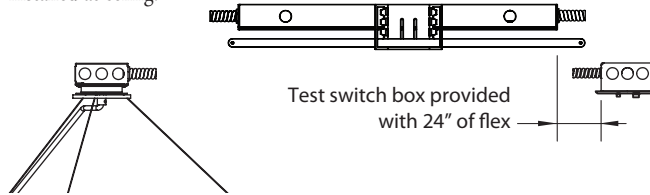

### WATTS / LUMENS / WEIGHT

Diameter	Watts	Delivered Lumens	Weight
6'	140	13,014	40 lb
8'	188	17,352	50 lb

### JOINER

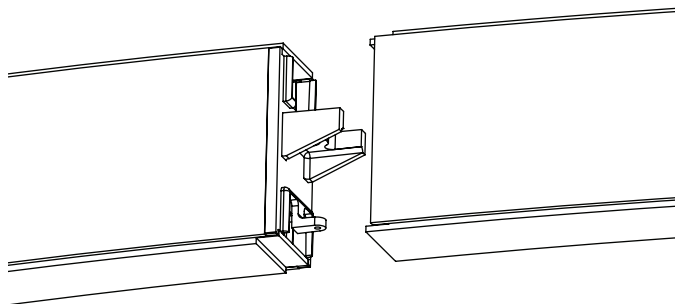

## OPTIONS

### DRIVER

Supplied standard with 0–10V programmable, 1% dimming, 120/277V, 50/60 Hz.

### OPTIONAL DRIVER

#### BDIM-W11

- Lutron EcoSystem LDE14 Series
- Dims to 1%
- Fade to off.

### TRAXON LIGHT DRIVE

(order separately)

#### BTRAXW – white faceplate

- Standalone, wall-mounted (12V power supply included) DMX controller for RGB LED that provides direct access to fixtures.
- Tune color and brightness with the Light-Drive wheel.
- Fully dimmable white mode button.
- See [www.traxon-usa.com](http://www.traxon-usa.com) for details.

### SEPARATE SWITCHING

Control uplight separately from downlight. Order **SS**.

### AIRCRAFT CABLE

**Note:** Aircraft cable suspension not recommended for outdoor use, where fixture will be exposed to water, or subject to wind oscillation. Avoid use near HVAC vents and in environments with corrosive chemical vapors, such as swimming pools.

### ACRYLIC DIFFUSER CLEANING

**Warning:** Do not clean with ammonia based cleaners (e.g. Windex®). Use only water or cleaners specifically formulated for cleaning plastics.