

DOS CIRCULAR DIRECT/INDIRECT WHITE LED WITH OPAL ACRYLIC LENS

**DELRAY
LIGHTING
INCORPORATED**

DOS LED CIRCLES

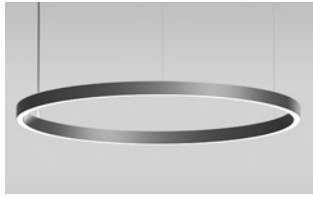

TYPE:

PROJECT:

ORDER NUMBER:

Model#	Finish	LEDs	Mount	Option	Option
UDC2 —2 ft.	S —Silver	W30	S —Separate	BDIM-W11	SS
UDC3 —3 ft.	W —White	W35	SR —Sep. Remote		
UDC4 —4 ft.	K —Black	W40	CS —Cen. Standard		
UDC5 —5 ft.		Red	CR —Cen. Remote		
		Blue	NCR —Nexus CR		
		SQ —RGB	SREM —Separate EM		
			CREM —Central EM		

CONSTRUCTION

- Extruded aluminum outer housing with direct/indirect white frosted acrylic diffuser. 8 ft. gray or white 18 AWG adjustable power cord and AC cables with push button grippers supplied, standard. Specify **XP** for additional length (25 ft. max.).

WHITE LEDs

- Nichia Corp. NFSL757 tight bin chips on aluminum clad boards. 90 CRI.
- **W30** (3000K), **W35** (3500K), and **W40** (4000K) white color temperatures.
- Drivers are programmable constant current, 0–10V, 1% dimming, standard.
- 2 and 3 ft. fixtures require one driver (specify **SS** for Separate Switching). 4 and 5 ft. fixtures require two drivers.

CUSTOM LUMEN OUTPUT REDUCTION

- Factory set custom reduced-lumen output driver configuration. Order **XL**. Specify lumens.

COLOR LEDs

- **Red** and **Blue** are tape light, with two 12V constant voltage drivers. **SQ**—RGB are Nichia custom boards, with two 100W, 24V constant voltage drivers and DMX interface.
- Optional DMX wall box control offered separately (For details, see page 2.)

STANDARD CANOPY

- Drivers and DMX module installed in surface mount canopy. For remote driver installation, see page 2.
- cUL listed for dry locations only.
- Specify:
 - S, CS**—standard canopy (10" x 2.25") Mounts to all standard J-boxes.
 - SR, CR, NCR**—remote canopy (3" x 0.45") Mounts to 3" mudring.
- cUL listed for dry locations only.

Example:

UDC5 | S | W40 | SR | BDIM-W11 | SS

- BTRAXW**—Traxon Light Drive (enter quantity): _____
- XP**—Extra power cord (in inches; max. 25 ft.): _____
- XL**—custom lumen reduction (specify lumens): _____

- UDC2** — 2 ft.
- UDC3** — 3 ft.
- UDC4** — 4 ft.
- UDC5** — 5 ft.

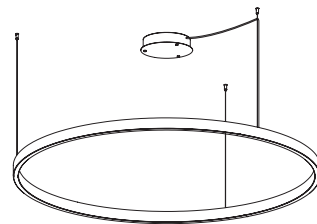
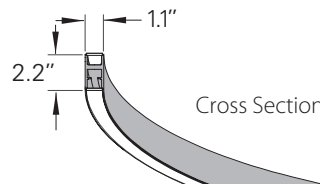

S — Separate

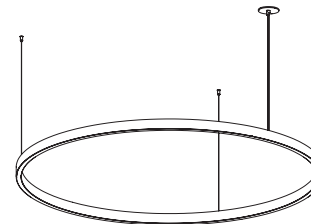

SR — Separate Remote

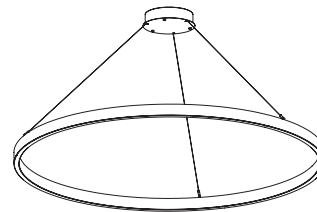

CS — Central Standard

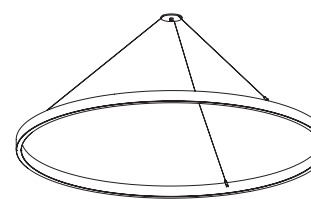

CR — Central Remote

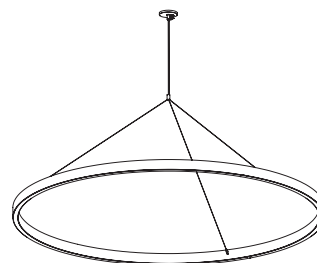

NCR — Nexus Central Remote

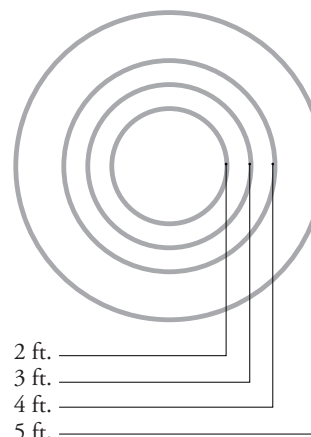

BURBANK,
CALIFORNIA,
91505
WWW.
DELRAY
LIGHTING.
COM

5 FT. LED

UDCS.W35

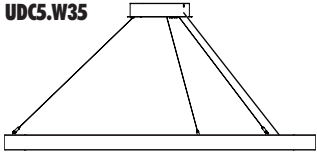

CP DISTRIBUTION

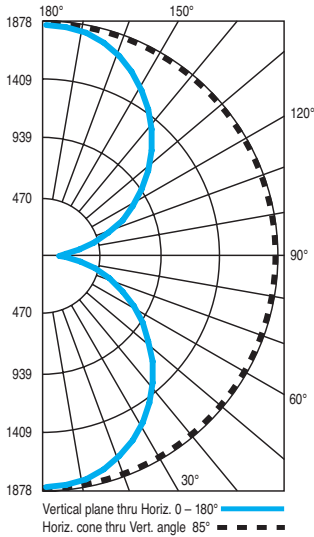

COEFFICIENTS

% CEILING 80 (20% FLOOR)			
% WALL 70	50	30	
0	107	107	107
1	97	93	89
2	88	81	74
3	80	71	63
4	73	62	54
5	67	55	47
6	62	50	41
7	57	45	37
8	53	41	33
9	49	37	29
10	46	34	27

NOTES

UDCS.W35

117W LEDs, 3500°K
Total lumens: 10,844

CRI: 90
R9 ≥ 72

DOS CIRCULAR REMOTE DRIVERS

Driver must be accessible after installation. For suspended and hard lid ceilings with access panels. Canopy mounts to mud ring attached to J-box.

NOTE: Multiple drivers must be mounted no less than 4 inches apart side-by-side, and 1 inch apart end-to-end, to avoid overheating.

Standard pendant length: 8 ft. Specify **XP** for extra pendant.
Maximum canopy to fixture distance: 25 ft. Maximum canopy to driver distance: 100 ft. (with 10 AWG wire).



Remote Driver Canopy
3.8 x 0.45 in.

SR – Separate mount driver installation.

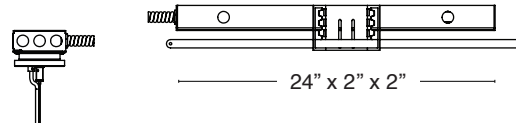

CR – Central mount remote driver installation.

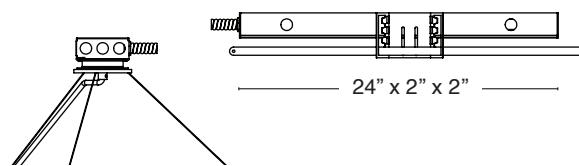

SR or **CREM** – Separate or Central Emergency. *T-bar install shown, below.*

Emergency battery pack provides 7W for 90 minutes. (12W also available.)
Remote install only. Red driver light and test switch mounted in handy box installed at ceiling.

WATTS / LUMENS

Diameter	Watts	Total Lumens	Delivered Lumens
2'	47	8,150	4,337
3'	70	12,250	6,507
4'	94	16,350	8,676
5'	117	20,450	10,844

AIRCRAFT CABLE

Note: Aircraft cable suspension not recommended for outdoor use, where fixture will be exposed to water, or subject to wind oscillation. Avoid use near HVAC vents and in environments with corrosive chemical vapors, such as swimming pools.

ACRYLIC DIFFUSER CLEANING

Warning: Do not clean with ammonia based cleaners (e.g. Windex®). Use only water or cleaners specifically formulated for cleaning plastics.

OPTIONS

DRIVER

Supplied standard with 0–10V programmable, 1% dimming, 120/277V, 50/60 Hz.

OPTIONAL DRIVER

BDIM-W11

- Lutron EcoSystem LDE14 Series
- Dims to 1%
- Fade to off.

TRAXON LIGHT DRIVE

(order separately)

BTRAXW – white faceplate

- Standalone, wall-mounted (12V power supply included) DMX controller for RGB LED that provides direct access to fixtures.
- Tune color and brightness with the Light-Drive wheel.
- Fully dimmable white mode button.
- See www.traxon-usa.com for details.

NOTES

UDCS.W35

117W LEDs, 3500°K
Total lumens: 10,844

CRI: 90
R9 ≥ 72

AIRCRAFT CABLE

Note: Aircraft cable suspension not recommended for outdoor use, where fixture will be exposed to water, or subject to wind oscillation. Avoid use near HVAC vents and in environments with corrosive chemical vapors, such as swimming pools.

ACRYLIC DIFFUSER CLEANING

Warning: Do not clean with ammonia based cleaners (e.g. Windex®). Use only water or cleaners specifically formulated for cleaning plastics.

SEPARATE SWITCHING

Control uplight separately from downlight. Order **SS**.

RED BRAIDED CORD

Red braided power cord.
Order **RBRD**.

