

8" CYLINDER HORIZONTAL UPLIGHT / VERTICAL LAMP WALL MOUNT DOWNLIGHT

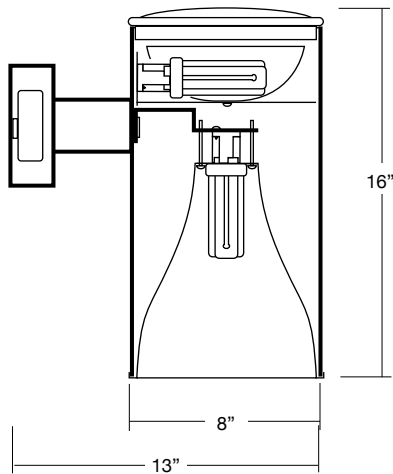

Wall Mount Cylinder
(shown w/**WL**-Wet Location Lens)



Clear Alzak® Haze



Wheat Alzak® Haze



Black Baffle



Splay with
Fresnel Lens

SPECIFICATION INFORMATION

CYLINDER HOUSING

Constructed of seamless extruded aluminum, with a powder coat finish. 14" standard height; dimming and emergency ballast add 4". Fixture mounts to standard J-box.

REFLECTOR

Reflector is anodized, specular, durable and anti-iridescent; available in 30° cutoff (**.30**). Finishes are **A**-Clear Alzak® Haze or **G**-Wheat Alzak® Haze

TRIM OPTIONS

B-Black baffle
SP-Splay Fresnel Lens

BALLAST

Electronic enclosed, class P, HPF is supplied standard in 120V or 277V. Ballasts use 4-pin lamps and provide rapid start, .99 power factor with THD<10%.

ELECTRICAL

Ballast mounted in canopy for easy access. U.L. listed for use in damp locations. For wet locations, specify convex lens **WL**.

ACCESSORIES

WL-Wet location convex lens

FINISHES

BM-Brushed Metal, Anodized
BZ-Bronze
K-Black
W-White
S-Silver
CC-Custom Color (Must specify RAL color number.)

ORDERING INFORMATION

LAMP

2-18 18W triple tube
2-26 26W triple tube
2-32 32W triple tube
2-42 42W triple tube

120V ELECTRIC

CUH8218.1E 18W triple tube
CUH8226.1E 26W triple tube
CUH8232.1E 32W triple tube
CUH8242.1E 42W triple tube

277V ELECTRIC

CUH8218.2E 18W triple tube
CUH8226.2E 26W triple tube
CUH8232.2E 32W triple tube
CUH8242.2E 42W triple tube

SPECIFY FINISH:

BM-Brushed Metal, anodized
BZ-Bronze
K-Black
W-White

S-Silver
CC-Custom Color
Specify RAL color #:

SUBMITTAL INFORMATION

TYPE:

PROJECT:

NOTES:

DESCRIPTION:

**DELRAY
LIGHTING
INCORPORATED**

CUH8200

**BURBANK,
CALIFORNIA,
91505
WWW.
DELRAY
LIGHTING.
COM**

APR 2014

CLEAR ALZAK 30°

CUH8218

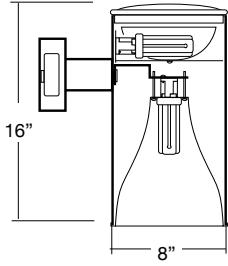

CLEAR ALZAK 30°

CUH8226

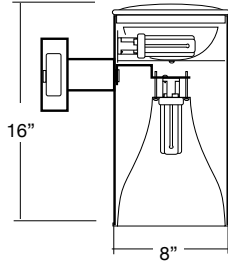

CLEAR ALZAK 30°

CUH8232

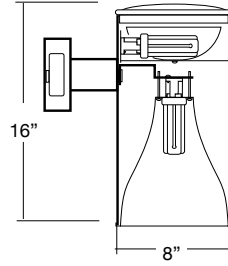

CONE OF LIGHT

MTG. HT.	FC/0°	DIA.
4'	65	3.7
6'	29	5.5
8'	17	7.3
10'	11	9.2
12'	8	11.0

50% FC at edge

MTG. HT.	FC/0°	DIA.
4'	81	3.7
6'	39	5.5
8'	19	7.3
10'	12	9.2
12'	9	11.0

50% FC at edge

MTG. HT.	FC/0°	DIA.
4'	95	4.2
6'	42	6.4
8'	24	8.5
10'	15	10.7
12'	11	12.8

50% FC at edge

ACCESSORIES

WL—Wet location lens

Convex 3/16" tempered soda lime glass lens and silicone gasket keep water away from fixture interior.



CP DISTRIBUTION: UP LIGHT

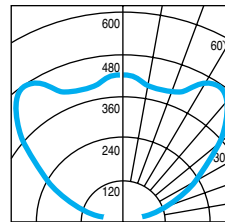
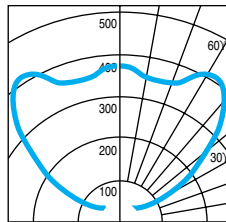
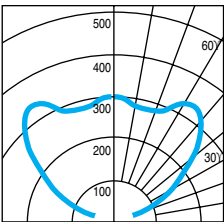

CP DISTRIBUTION: DOWNLIGHT

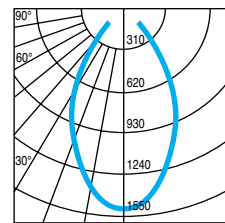
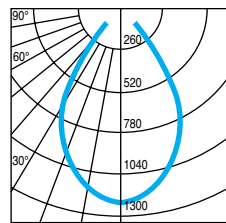
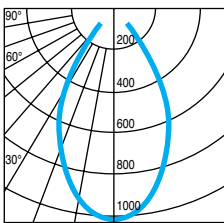

NOTES

CUH8218

2-18W triple tube
G24q-2 electronic socket
Total lumens: 1250
Spacing criteria: .9
Wheat Alzak x.90

CUH8226

2-26W triple tube
G24q-3 electronic socket
Total lumens: 1800
Spacing criteria: .9
Wheat Alzak x.90

CUH8232

2-32W triple tube
G24q-3 electronic socket
Total lumens: 2400
Spacing criteria: .9
Wheat Alzak x.90