

ASPECT GLASS LUMINAIRE

**DELRAY
LIGHTING
INCORPORATED**

238



TYPE:

PROJECT:

ORDER NUMBER:

Model#	Paint Finish	Glass Color	Wattage	Voltage	Ballast
	Hammertone	Indigo	18, 26	1-120V	E-Electronic
	Silver	Marine	32, 42	2-277V	D3, D5, D8,
	White	Opal			D9-Dimming
	CC-Custom	Tangerine			only for items
	RAL color				marked ♦.
					(See back page
					for details.)

Example:

2382	W	M	32	1	E
------	---	---	----	---	---

ARMATURE

Suspends from cable or rod and is constructed of extruded aluminum, securely fastened to cast wire way top. Ballast fits inside extruded cylinder attached to lamp holder for pulldown access. U.L. listed for damp locations.

2380
Fluorescent

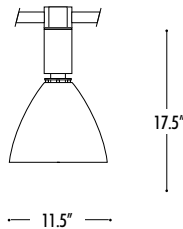

SURFACE MOUNT

Steel canopy mounts to all recessed J-boxes. Ballast fits inside extruded cylinder **2381** or horizontally in flat canopy **2385**. Specify **EM** for emergency battery pack, available on **2381** only. The 650 lumen battery pack adds 9 3/4" to canopy height; 13 3/4" with the 1300 lumen unit. U.L. listed for damp locations.

2381
Fluorescent

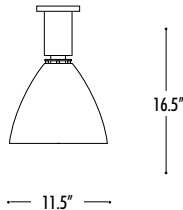

2385♦
Fluorescent

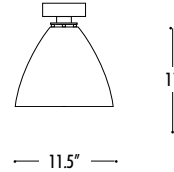

PENDANT MOUNT

Canopies mount to standard J-box. Ballast fits inside extruded cylinder **2382** or horizontally in flat canopy **2387**. Pendant is 6' standard or can be specified in any length with 12' max for CFL (3' max. dimming). Specify **EM** for emergency battery pack, available on **2382** only. The 650 lumen battery pack adds 9 3/4" to canopy height, 13 3/4" with the 1300 lumen unit. U.L. listed for damp locations.

2382
Fluorescent

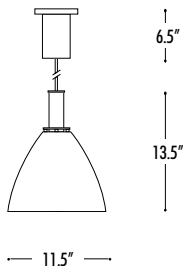

2387♦
Fluorescent

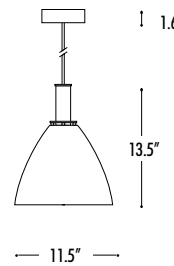

WALL MOUNT

4" square by 3/16" thick aluminum wall plate mounts to 3" mud ring on 2 3/4" vertical, centered holes. Fixture connects to extruded aluminum arm, which is securely fastened to cast wire way top. Ballast fits inside extruded cylinder **2383** or in flat canopy **2384**. U.L. listed for damp locations.

2383
Fluorescent

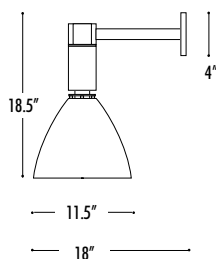

2384♦
Fluorescent

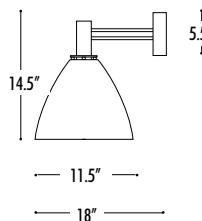

**BURBANK,
CALIFORNIA,
91505
WWW.
DELRAY
LIGHTING.
COM**

FLUORESCENT

1-32W PLT

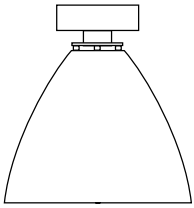

CP DISTRIBUTION

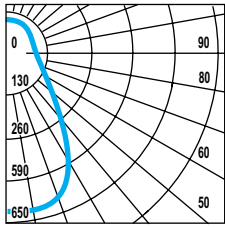

COEFFICIENTS

% CEILING 80 (20% FLOOR)

% WALL	70	50	30
0	82	82	82
1	76	73	70
2	70	65	61
3	66	59	55
4	61	54	49
5	57	49	44
6	53	45	39
7	49	41	36
8	46	37	32
9	43	34	29
10	39	31	25

NOTES

238232

1-32W triple tube
G24q-3 electronic socket
Total lumens: 2400
Spacing criteria: 1.2

BALLAST INFO

DIMMING

- Dimming only available for items marked **◆** on page 1.
- Max. 3' pendant length.
- Voltage *must* be specified.
- Controls lumen output down to $\pm 5\%$.
- Compatible dimmers required for all ballasts.
- **D3** Advance Mark X for 18, 26, 32 or 42W lamp.
- **D5** Advance Mark VII for 18, 26, 32 or 42W lamp.
- **D8** Lutron Hi-Lume 1% for 26 or 32W lamp. Controls lumen output down to $\pm 1\%$.
- **D9** Lutron EcoSystem for 18, 26, 32 or 42W lamp. Controls lumen output down to $\pm 5\%$.

EMERGENCY

- Voltage *must* be specified.
- **EM** emergency power provides 650 lumens for one lamp for 90 minutes. Ht.=15.25"
- **EM13** emergency power provides 1300 lumens for one lamp for 90 minutes. Ht.=18.75"

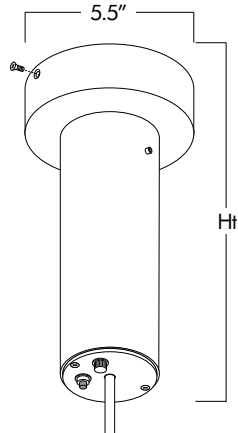

WALL MOUNTING

WALL PREPARATION

- For model 23833.
- Mount holes must be aligned vertical center, as shown:

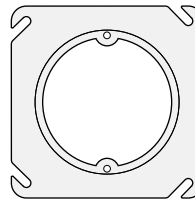

2389 ARM EXTENSION

- Specify arm length, up to 36" maximum.
Example: **2389X** (X=length)
- Aircraft cable, grip locks and mounting hardware included.

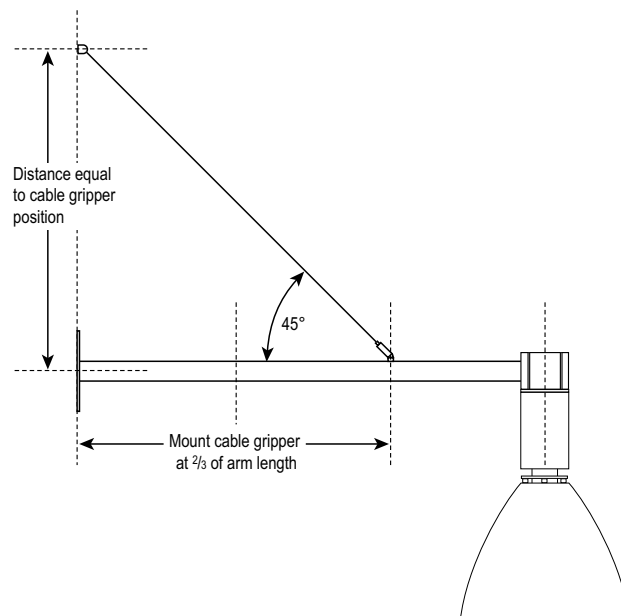

OPTIONS

AL-Acrylic Lens. For security and food service installations.
Use with CFL lamps *only*.