

ASPECT GLASS WITH PERFORATED SHADE

**DELRAY
LIGHTING
INCORPORATED**

214



TYPE:

PROJECT:

ORDER NUMBER:

| Model# | Paint Finish | Glass Color | Wattage | Voltage | Ballast |
|--------|--------------------|-------------------|----------------|----------------|----------------------|
| | H ammertone | I ndigo | 18, 26, | 1 -120V | E -Electronic |
| | S ilver | M arine | 32, 42 | 2 -277V | D5, D8, D |
| | W hite | O pal | | | 9 -Dimming |
| | CC -Custom | T angerine | | | only for items |
| | RAL color | | | | marked ◆ . |
| | | | | | (See back page |
| | | | | | for details.) |

Example:

| | | | | | |
|------|---|---|----|---|---|
| 2142 | W | M | 32 | 1 | E |
|------|---|---|----|---|---|

ARMATURE

Suspends from cable or rod, constructed of extruded aluminum, and is securely fastened to cast wire way top. Ballast fits inside extruded cylinder attached to lamp holder for pulldown access. U.L. listed for damp locations.

2140
Fluorescent

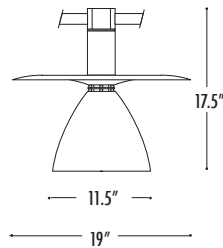

SURFACE MOUNT

Steel canopy mounts to all recessed J-boxes. Ballast fits inside extruded cylinder **2141** or horizontally in flat canopy **2145**. Specify **EM** for emergency battery pack, available on **2141** only. The 650 lumen battery pack adds 9 3/4" to canopy height, 13 3/4" with the 1300 lumen unit. U.L. listed for damp locations.

2141
Fluorescent

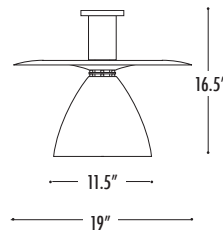

2145◆
Fluorescent

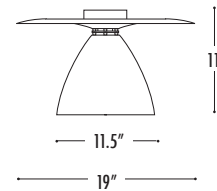

PENDANT MOUNT

Canopies mount to standard J-box. Ballast fits inside extruded cylinder **2142** or horizontally in flat canopy **2147**. Pendant is 6' standard or can be specified in any length with 12' max for CFL (3' max. dimming). Specify **EM** for emergency battery pack, available on **2142** only. The 650 lumen battery pack adds 9 3/4" to canopy height, 13 3/4" with the 1300 lumen unit. U.L. listed for damp locations.

2142
Fluorescent

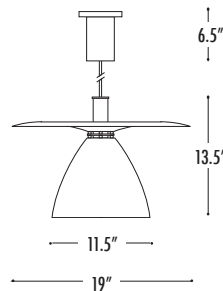

2147◆
Fluorescent

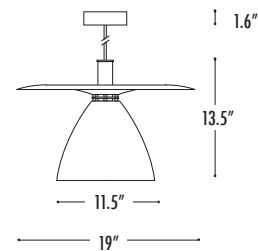

WALL MOUNT

4" square by 3/16" thick aluminum wall plate mounts to 3" mud ring on 2 3/4" vertical, centered holes. Fixture connects to extruded aluminum arm, which is securely fastened to cast wire way top. Ballast fits inside extruded cylinder **2143**. U.L. listed for damp locations.

2143
Fluorescent

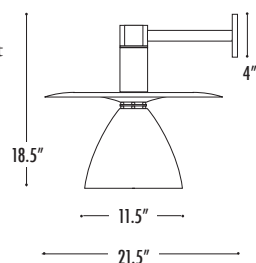

**BURBANK,
CALIFORNIA,
91505
WWW.
DELRAY
LIGHTING.
COM**

FLUORESCENT

1-32W PLT



CP DISTRIBUTION

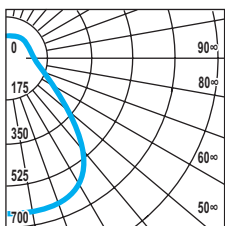

COEFFICIENTS

% CEILING 80 (20% FLOOR)

| % WALL | 70 | 50 | 30 |
|--------|----|----|----|
| 0 | 84 | 84 | 84 |
| 1 | 77 | 74 | 71 |
| 2 | 72 | 67 | 63 |
| 3 | 67 | 61 | 56 |
| 4 | 62 | 55 | 49 |
| 5 | 58 | 50 | 44 |
| 6 | 54 | 46 | 40 |
| 7 | 50 | 42 | 36 |
| 8 | 47 | 38 | 33 |
| 9 | 44 | 35 | 29 |
| 10 | 40 | 31 | 25 |

NOTES

214232

1-32W triple tube
G24q-3 electronic socket
Total lumens: 2400
Spacing criteria: 1.2

BALLAST INFO

DIMMING

- Dimming only available for items marked **◆** on page 1.
- Max. 3' pendant length.
- Voltage *must* be specified.
- Controls lumen output down to $\pm 5\%$.
- Compatible dimmers required for all ballasts.
- **D5** Advance Mark VII for 18, 26, 32 or 42W lamp.
- **D8** Lutron Hi-Lume 1% for 26 or 32W lamp. Controls lumen output down to $\pm 1\%$.
- **D9** Lutron EcoSystem for 18, 26, 32 or 42W lamp. Controls lumen output down to $\pm 5\%$.

EMERGENCY

- Voltage *must* be specified.
- **EM** emergency power provides 650 lumens for one lamp for 90 minutes. Ht.=15.25"
- **EM13** emergency power provides 1300 lumens for one lamp for 90 minutes. Ht.=18.75"

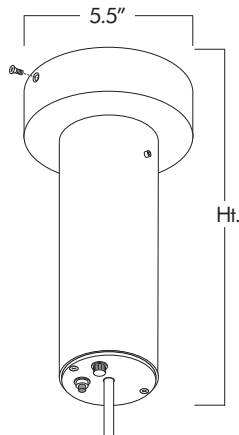

WALL MOUNTING

WALL PREPARATION

- For model 2143.
- Mount holes must be aligned vertical center, as shown:

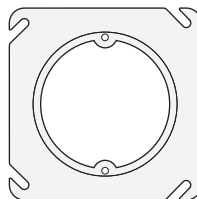

2149 ARM EXTENSION

- Specify arm length, up to 36" maximum.
Example: **2149X** (X=length)
- Aircraft cable, grip locks and mounting hardware included.

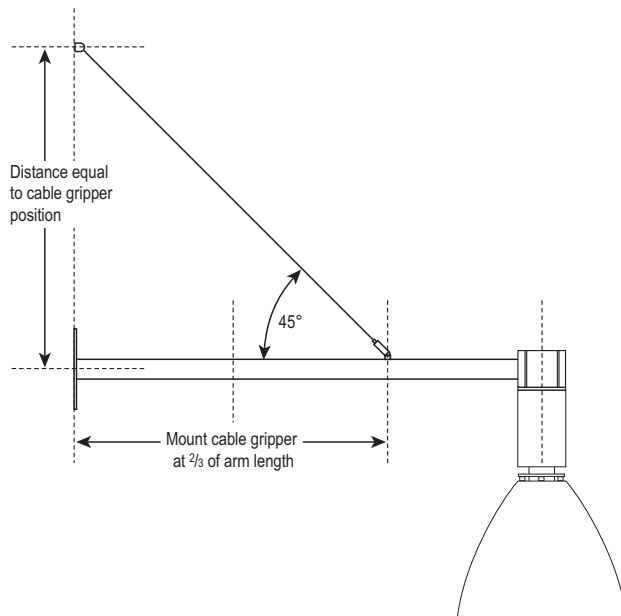

OPTIONS

AL-Acrylic Lens. For security and food service installations.
Use with CFL lamps *only*.